

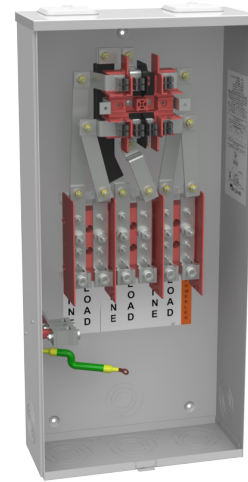

# 127TB



Catalog Number	127TB
Marketing Product Description	7 Terminal Ring Type 2 Small Closing Plate Link Bypass 200 Ampere
UPC	784572102491
Length (IN)	6
Width (IN)	14.125
Height (IN)	30
Brand Name	Milbank
Type	Ring Type Meter Socket
Application	Meter Socket
Standard	UL Listed;Type 3R
Voltage Rating	Up to 600 Volts Alternating Current
Amperage Rating	200 Continuous Ampere
Phase	3 Phase
Frequency Rating	60 Hertz
Size	6L x 14.125W x 30H
Number Of Cutouts	0
Cutout Size	No Main Breaker
Cable Entry	Overhead or Underground
Terminal	Single Mechanical
Insulation	Fiberglass with Resin
Mounting	Surface Mount

Enclosure	G90 Galvanized Steel with Powder Coat Finish
Jaw Quantity	7 Terminal
Bypass Type	Link Bypass
Number of Meter Positions	1 Position
Equipment Ground	Ground Lug
Hub Opening	Twin Small Closing Plates
Line Side Wire Range	1/0 - 250 kcmil
Load Side Wire Range	1/0 - 250 kcmil
Number Of Receptacles	0

Please consult serving utility for their requirements prior to ordering or installing, as specifications and approvals vary by utility and may require local electrical inspector approval. All installations must be installed by a licensed electrician and must comply with all national and local codes, laws and regulations. Milbank reserves the right to make changes in specifications and features shown without notice or obligation.



# 127TB

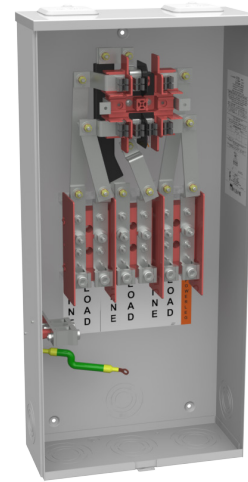

Catalog Number	127TB
Marketing Product Description	7 Terminal Ring Type 2 Small Closing Plate Link Bypass 200 Ampere
UPC	784572102491
Length (IN)	6
Width (IN)	14.125
Height (IN)	30
Brand Name	Milbank
Type	Ring Type Meter Socket
Application	Meter Socket
Standard	UL Listed;Type 3R
Voltage Rating	Up to 600 Volts Alternating Current
Amperage Rating	200 Continuous Ampere
Phase	3 Phase
Frequency Rating	60 Hertz
Size	6L x 14.125W x 30H
Number Of Cutouts	0
Cutout Size	No Main Breaker
Cable Entry	Overhead or Underground
Terminal	Single Mechanical
Insulation	Fiberglass with Resin
Mounting	Surface Mount

Enclosure	G90 Galvanized Steel with Powder Coat Finish
Jaw Quantity	7 Terminal
Bypass Type	Link Bypass
Number of Meter Positions	1 Position
Equipment Ground	Ground Lug
Hub Opening	Twin Small Closing Plates
Line Side Wire Range	1/0 - 250 kcmil
Load Side Wire Range	1/0 - 250 kcmil
Number Of Receptacles	0

Please consult serving utility for their requirements prior to ordering or installing, as specifications and approvals vary by utility and may require local electrical inspector approval. All installations must be installed by a licensed electrician and must comply with all national and local codes, laws and regulations. Milbank reserves the right to make changes in specifications and features shown without notice or obligation.