

# Type 1, 3, & 3R Enclosures

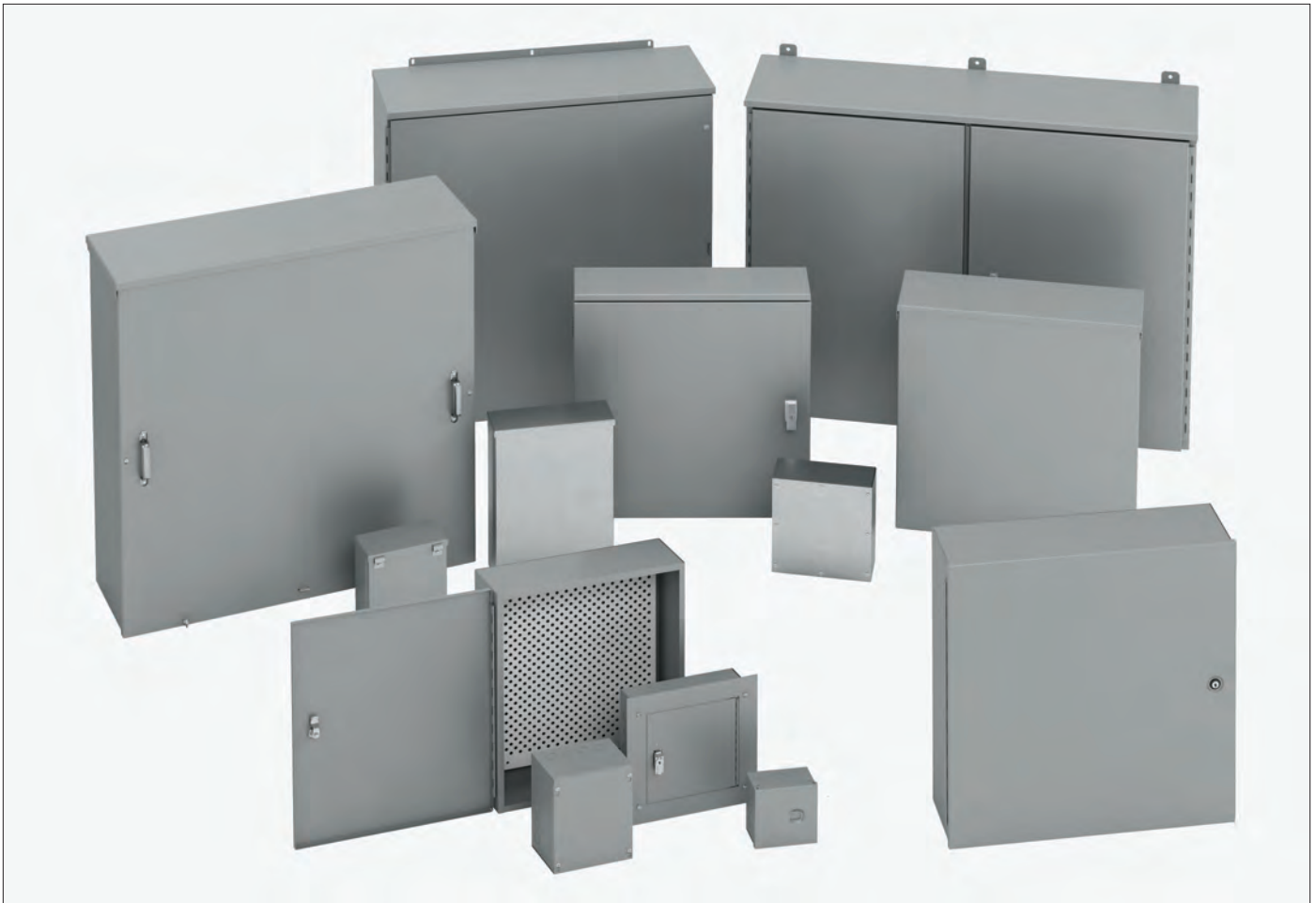

Type 1, 3, & 3R Enclosures

Junction Boxes Type 1 Screw Cover .....	50-53
Junction Boxes Type 1 Hinge Cover .....	54-55
Junction Boxes Type 3R Screw Cover .....	56-57
Junction Boxes Type 3R Hinge Cover .....	58-59
Junction Boxes Type 3 Screw Cover Gasketed .....	60-61
Junction Boxes Type 3 Weatherproof Screw Cover .....	62-63
Panel Enclosures Type 1 Small .....	64-65
Panel Enclosures Type 1 Medium .....	66-67
Panel Enclosures Type 1 Large .....	68-69
Panel Enclosures Type 1 Locking Hinge Cover w/Perforated Panel .....	70-71
Panel Enclosures Type 3R Small Continuous Hinge Cover .....	72-73
Panel Enclosures Type 3R Large Continuous Hinge Cover .....	74-75
Panel Enclosures Type 3R Double-Door .....	76-77
Utility Cabinets Type 1 Telephone Cabinets .....	78-80
Utility Cabinets Type 3R Telephone Cabinets .....	81-82
Utility Cabinets Type 3R Screw Cover Current Transformer Cabinets .....	83-85
Utility Cabinets Type 3R Hinge Cover Current Transformer Cabinets .....	86-87

# Type 1, 3, & 3R Enclosures

## Junction Boxes Type 1 Screw Cover - Painted & Galvanized Data and Illustration Sheet

Type 1, 3, & 3R Enclosures

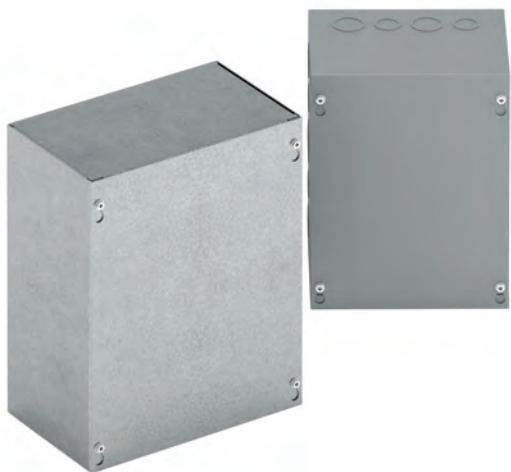

### Application

- Used as wiring boxes, junction and pull boxes
- Protects against contact with enclosed equipment

### Standards

- UL 50 listed, Type 1
- CSA C22.2 No. 40 certified, Type 1
- Conforms to NEMA standard for Type 1

### Finish

- Wash and phosphate undercoat or galvanized steel
- ANSI 61 gray acrylic electrocoat finish

### Accessories

- Ground lug kit
- Touch-up paint
- See Accessories section

### Construction

- Enclosure and cover are fabricated from code gauge steel or galvanized steel, (see table)
- Enclosure body has mounting holes on the back
- Enclosures are available with or without knockouts on the sides, top and bottom ends
- Cover is secured to the body with plated pan head combo screws
- Keyhole slots provided in the cover allow easy access to the inside without removing the screws
- Hole provision for optional ground lug kit
- Ground screw provided

### Discount Schedule: A2

### Subclass: AN0 (painted) & AX1 (galvanized)

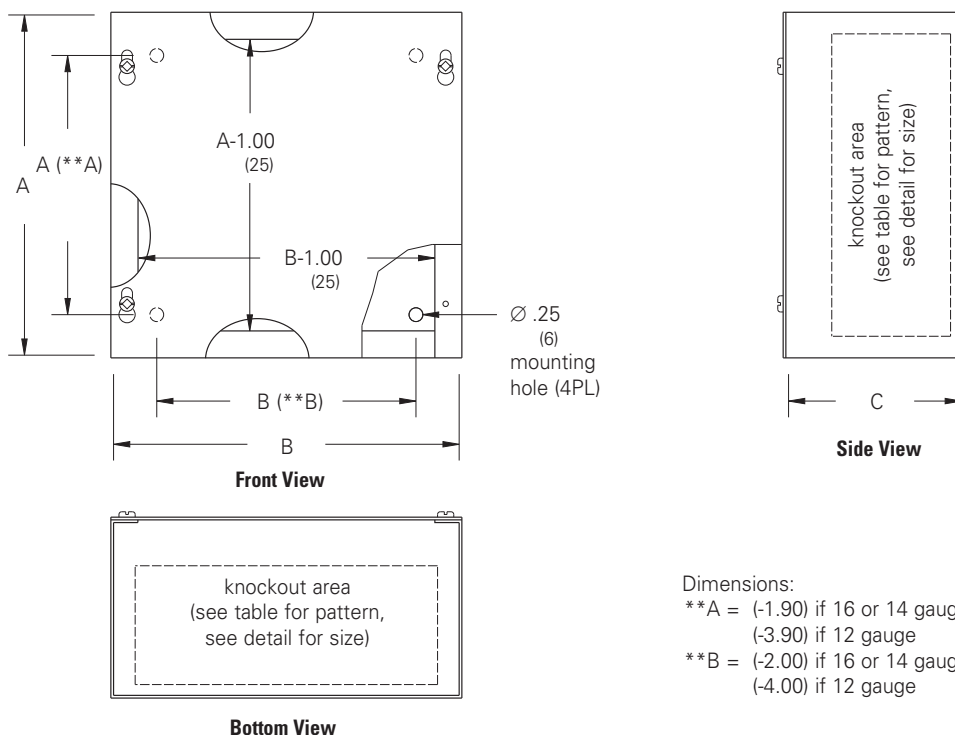

**Notes:** We can provide special sizes, finishes and other modifications. Consult the factory for your special requirements. Dimensions are in inches. Millimeters shown are for reference only. Data subject to change without notice.

## Junction Boxes Type 1 Screw Cover - Painted & Galvanized

Catalog Number

Subclass: ANO - Painted & AX1 - Galvanized

Enclosure Catalog Number				Enclosure Size		Gauge	Knockout Pattern	Knockout Pattern
Painted		Galvanized		Height x Width x Depth			Each Side	Top & Bottom
KO	No KO	KO	No KO	A x B x C				
				in.	mm			
443 SC	443 SC NK	443 SCGV	443 SCGV NK	4.00 x 4.00 x 3.00	102 x 102 x 76	16	(C D)	(C D)
444 SC	444 SC NK	444 SCGV	444 SCGV NK	4.00 x 4.00 x 4.00	102 x 102 x 102	16	(C D)	(C D)
644 SC	644 SC NK	644 SCGV	644 SCGV NK	6.00 x 4.00 x 4.00	152 x 102 x 102	16	(C D E)	(C D)
663 SC	663 SC NK	663 SCGV	663 SCGV NK	6.00 x 6.00 x 3.00	152 x 152 x 76	16	(C D E)	(C D E)
664 SC	664 SC NK	664 SCGV	664 SCGV NK	6.00 x 6.00 x 4.00	152 x 152 x 102	16	(C D E)	(C D E)
863 SC	863 SC NK	863 SCGV	863 SCGV NK	8.00 x 6.00 x 4.300	203 x 152 x 76	16	(G H I J)	(C D E)
864 SC	864 SC NK	864 SCGV	864 SCGV NK	8.00 x 6.00 x 4.00	203 x 152 x 102	16	(G H I J)	(C D E)
884 SC	884 SC NK	884 SCGV	884 SCGV NK	8.00 x 8.00 x 4.00	203 x 203 x 102	16	(G H I J)	(G H I J)
--	1064 SC NK	--	1064 SCGV NK	10.00 x 6.00 x 4.00	254 x 152 x 102	16	--	--
1084 SC	1084 SC NK	1084 SCGV	1084 SCGV NK	10.00 x 8.00 x 4.00	254 x 203 x 102	16	(G H I J)	(G H I J)
10104 SC	10104 SC NK	10104 SCGV	10104 SCGV NK	10.00 x 10.00 x 4.00	254 x 254 x 102	16	(G H I J)	(G H I J)
1264 SC	1264 SC NK	--	1264 SCGV NK	12.00 x 6.00 x 4.00	305 x 152 x 102	16	(D E F G H)	(C D E)
1284 SC	1284 SC NK	1284 SCGV	1284 SCGV NK	12.00 x 8.00 x 4.00	305 x 203 x 102	16	(D E F G H)	(G H I J)
12104 SC	12104 SC NK	12104 SCGV	12104 SCGV NK	12.00 x 10.00 x 4.00	305 x 254 x 102	16	(D E F G H)	(D E F G H)
12124 SC	12124 SC NK	12124 SCGV	12124 SCGV NK	12.00 x 12.00 x 4.00	305 x 305 x 102	16	(D E F G H)	(D E F G H)
--	15154 SC NK	15154 SCGV	--	15.00 x 15.00 x 4.00	381 x 381 x 102	16	(C D E F G H I)	(C D E F G H I)
16124 SC	16124 SC NK	16124 SCGV	16124 SCGV NK	16.00 x 12.00 x 4.00	406 x 305 x 102	16	(C D E F G H I)	(D E F G H)
16164 SC	16164 SC NK	16164 SCGV	--	16.00 x 16.00 x 4.00	406 x 406 x 102	16	(C D E F G H I)	(C D E F G H I)
18124 SC	18124 SC NK	18124 SCGV	18124 SCGV NK	18.00 x 12.00 x 4.00	457 x 305 x 102	16	(B C D E F G H I J)	(D E F G H)
--	18154 SC NK	18154 SCGV	--	18.00 x 15.00 x 4.00	457 x 381 x 102	16	(B C D E F G H I J)	(C D E F G H I)
18184 SC	18184 SC NK	18184 SCGV	18184 SCGV NK	18.00 x 18.00 x 4.00	457 x 457 x 102	16	(B C D E F G H I J)	(B C D E F G H I J)
24124 SC	24124 SC NK	24124 SCGV	--	24.00 x 12.00 x 4.00	610 x 305 x 102	16	(B C D E F G H I J)	(D E F G H)
--	24184 SC NK	24184 SCGV	--	24.00 x 18.00 x 4.00	610 x 457 x 102	16	(B C D E F G H I J)	(B C D E F G H I J)
24244 SC	24244 SC NK	24244 SCGV	24244 SCGV NK	24.00 x 24.00 x 4.00	610 x 610 x 102	14	(B C D E F G H I J)	(B C D E F G H I J)
--	30184 SC NK	30184 SCGV	30184 SCGV NK	30.00 x 18.00 x 4.00	762 x 457 x 102	16	(B C D E F G H I J)	(B C D E F G H I J)
30244 SC	30244 SC NK	30244 SCGV	30244 SCGV NK	30.00 x 24.00 x 4.00	762 x 610 x 102	14	(B C D E F G H I J)	(B C D E F G H I J)
-	30304 SC NK	-	30304 SCGV NK	30.00 x 30.00 x 4.00	762 x 762 x 102	12	--	--

Type 1, 3, & 3R Enclosures

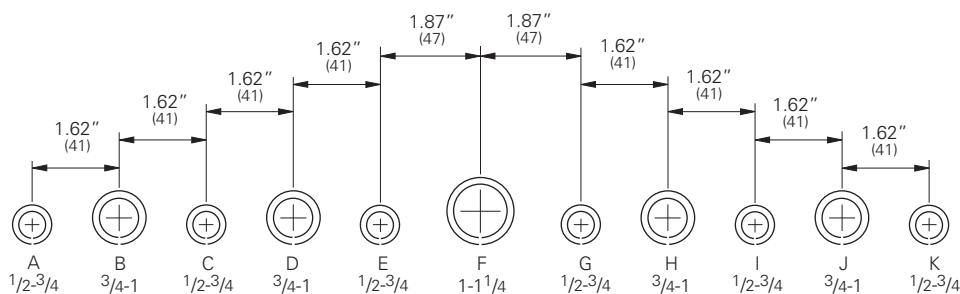

### Conduit Sizes

### Knockout Detail

Note: See table for applicable knockout pattern.

Notes: Dimensions are in inches. Millimeters shown are for reference only. Data subject to change without notice.

# Type 1, 3, & 3R Enclosures

## Junction Boxes

### Type 1 Screw Cover - Painted & Galvanized

Catalog Number

Subclass: ANO - Painted & AX1 - Galvanized

Type 1, 3, & 3R Enclosures

Enclosure Catalog Number				Enclosure Size		Gauge	Knockout Pattern	Knockout Pattern
Painted		Galvanized		Height x Width x Depth				
KO	No KO	KO	No KO	in.	mm			
666 SC	666 SC NK	666 SCGV	666 SCGV NK	6.00 x 6.00 x 6.00	152 x 152 x 152	16	(CDE)	(CDE)
866 SC	866 SC NK	866 SCGV	866 SCGV NK	8.00 x 6.00 x 6.00	203 x 152 x 152	16	(GHIJ)	(CDE)
886 SC	886 SC NK	886 SCGV	886 SCGV NK	8.00 x 8.00 x 6.00	203 x 203 x 152	16	(GHIJ)	(GHIJ)
1086 SC	1086 SC NK	1086 SCGV	1086 SCGV NK	10.00 x 8.00 x 6.00	254 x 203 x 152	16	(DEFGH)	(GHIJ)
10106 SC	10106 SC NK	10106 SCGV	10106 SCGV NK	10.00 x 10.00 x 6.00	254 x 254 x 152	16	(DEFGH)	(DEFGH)
--	1266 SC NK	--	--	12.00 x 6.00 x 6.00	305 x 152 x 152	16	--	--
--	1286 SC NK	--	1286 SCGV NK	12.00 x 8.00 x 6.00	305 x 203 x 152	16	--	--
12106 SC	12106 SC NK	12106 SCGV	12106 SCGV NK	12.00 x 10.00 x 6.00	305 x 254 x 152	16	(DEFGH)	(DEFGH)
12126 SC	12126 SC NK	12126 SCGV	12126 SCGV NK	12.00 x 12.00 x 6.00	305 x 305 x 152	16	(DEFGH)	(DEFGH)
--	15156 SC NK	--	15156 SCGV NK	15.00 x 15.00 x 6.00	381 x 381 x 152	16	--	--
16126 SC	16126 SC NK	16126 SCGV	16126 SCGV NK	16.00 x 12.00 x 6.00	406 x 305 x 152	16	(CDEFGHI)	(DEFGH)
16166 SC	16166 SC NK	16166 SCGV	16166 SCGV NK	16.00 x 16.00 x 6.00	406 x 406 x 152	16	(CDEFGHI)	(BCDEFGHIJ)
18126 SC	18126 SC NK	18126 SCGV	18126 SCGV NK	18.00 x 12.00 x 6.00	457 x 305 x 152	16	(BCDEFGHIJ)	(DEFGH)
--	18156 SC NK	--	18156 SCGV NK	18.00 x 15.00 x 6.00	457 x 381 x 152	16	--	--
18186 SC	18186 SC NK	18186 SCGV	18186 SCGV NK	18.00 x 18.00 x 6.00	457 x 457 x 152	16	(BCDEFGHIJ)	(BCDEFGHIJ)
--	24126 SC NK	--	24126 SCGV NK	24.00 x 12.00 x 6.00	610 x 305 x 152	16	--	--
24186 SC	24186 SC NK	24186 SCGV	24186 SCGV NK	24.00 x 18.00 x 6.00	610 x 457 x 152	16	(BCDEFGHIJ)	(BCDEFGHIJ)
--	24206 SC NK	--	24206 SCGV NK	24.00 x 20.00 x 6.00	610 x 508 x 152	14	--	--
24246 SC	24246 SC NK	24246 SCGV	24246 SCGV NK	24.00 x 24.00 x 6.00	610 x 610 x 152	14	(BCDEFGHIJ)	(BCDEFGHIJ)
--	30186 SC NK	--	30186 SCGV NK	30.00 x 18.00 x 6.00	762 x 457 x 152	16	--	--
30246 SC	30246 SC NK	30246 SCGV	30246 SCGV NK	30.00 x 24.00 x 6.00	762 x 610 x 152	14	(BCDEFGHIJ)	(BCDEFGHIJ)
--	30306 SC NK	--	30306 SCGV NK	30.00 x 30.00 x 6.00	762 x 762 x 152	12	--	--
36246 SC	36246 SC NK	--	36246 SCGV NK	36.00 x 24.00 x 6.00	914 x 310 x 152	14	(BCDEFGHIJ)	(BCDEFGHIJ)
--	36306 SC NK	--	36306 SCGV NK	36.00 x 30.00 x 6.00	914 x 762 x 152	12	--	--
--	36366 SC NK	--	36366 SCGV NK	36.00 x 36.00 x 6.00	914 x 914 x 152	12	--	--
--	48366 SC NK	--	48366 SCGV NK	48.00 x 36.00 x 6.00	1219 x 914 x 152	12	--	--
--	48486 SC NK	--	48486 SCGV NK	48.00 x 48.00 x 6.00	1219 x 1219 x 152	12	--	--
888 SC	888 SC NK	888 SCGV	888 SCGV NK	8.00 x 8.00 x 8.00	203 x 203 x 203	16	(GHIJ)	(GHIJ)
--	10108 SC NK	--	10108 SCGV NK	10.00 x 10.00 x 8.00	254 x 254 x 203	16	--	--
12128 SC	12128 SC NK	--	12128 SCGV NK	12.00 x 12.00 x 8.00	305 x 305 x 203	16	(DEFGH)	(DEFGH)
16128 SC	16128 SC NK	--	16128 SCGV NK	16.00 x 12.00 x 8.00	406 x 305 x 203	16	(CDEFGHI)	(DEFGH)
18128 SC	18128 SC NK	--	18128 SCGV NK	18.00 x 12.00 x 8.00	457 x 305 x 203	16	(BCDEFGHIJ)	(DEFGH)
18188 SC	18188 SC NK	--	18188 SCGV NK	18.00 x 18.00 x 8.00	457 x 457 x 203	16	(BCDEFGHIJ)	(BCDEFGHIJ)
24128 SC	24128 SC NK	--	24128 SCGV NK	24.00 x 12.00 x 8.00	610 x 305 x 203	16	(BCDEFGHIJ)	(DEFGH)
24188 SC	24188 SC NK	--	24188 SCGV NK	24.00 x 18.00 x 8.00	610 x 457 x 203	16	(BCDEFGHIJ)	(BCDEFGHIJ)
--	24208 SC NK	--	24208 SCGV NK	24.00 x 20.00 x 8.00	610 x 508 x 203	14	--	--
24248 SC	24248 SC NK	--	24248 SCGV NK	24.00 x 24.00 x 8.00	610 x 610 x 203	14	(BCDEFGHIJ)	(BCDEFGHIJ)
30248 SC	30248 SC NK	30248 SCGV	30248 SCGV NK	30.00 x 24.00 x 8.00	762 x 610 x 203	14	(BCDEFGHIJ)	(BCDEFGHIJ)
--	30308 SC NK	--	30308 SCGV NK	30.00 x 30.00 x 8.00	762 x 762 x 203	12	--	--
36248 SC	36248 SC NK	--	36248 SCGV NK	36.00 x 24.00 x 8.00	914 x 610 x 203	14	(BCDEFGHIJ)	(BCDEFGHIJ)
--	36308 SC NK	--	36308 SCGV NK	36.00 x 30.00 x 8.00	914 x 762 x 203	14	--	--
--	36368 SC NK	--	36368 SCGV NK	36.00 x 36.00 x 8.00	914 x 914 x 203	14	--	--

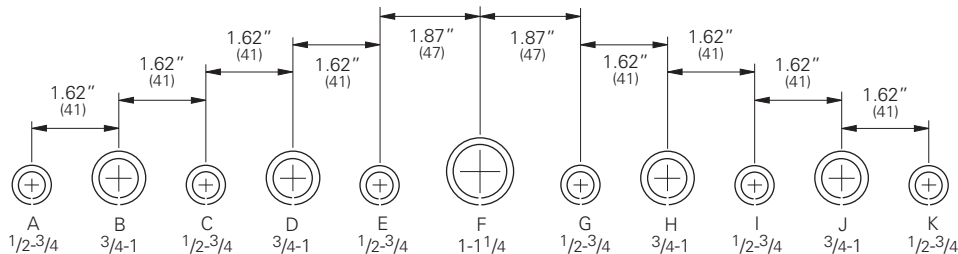

**Conduit Sizes Knockout Detail - Note:** See table for applicable knockout pattern.

**Notes:** Dimensions are in inches. Millimeters shown are for reference only. Data subject to change without notice.

## Junction Boxes Type 1 Screw Cover - Painted & Galvanized

Catalog Number

Subclass: ANO - Painted & AX1 - Galvanized

Enclosure Catalog Number				Enclosure Size			Gauge	Knockout Pattern	Knockout Pattern
Painted		Galvanized		Height x Width x Depth A x B x C				Each Side	Top & Bottom
KO	No KO	KO	No KO	in.	mm				
--	121210 SC NK	--	121210 SCGV NK	12.00 x 12.00 x 10.00	305 x 305 x 254		16	--	--
181810 SC	181210 SC NK	--	181210 SCGV NK	18.00 x 12.00 x 10.00	457 x 305 x 254		16	ⓀⓁⓁⓁⓁⓁⓁⓁⓁⓁⓁ	ⓁⓁⓁⓁⓁⓁ
181810 SC	181810 SC NK	--	181810 SCGV NK	18.00 x 18.00 x 10.00	457 x 457 x 254		16	ⓀⓁⓁⓁⓁⓁⓁⓁⓁⓁⓁ	ⓀⓁⓁⓁⓁⓁⓁⓁⓁⓁⓁ
--	241210 SC NK	--	241210 SCGV NK	24.00 x 12.00 x 10.00	610 x 305 x 254		16	--	--
241810 SC	241810 SC NK	--	241810 SCGV NK	24.00 x 18.00 x 10.00	610 x 457 x 254		16	ⓀⓁⓁⓁⓁⓁⓁⓁⓁⓁⓁ	ⓀⓁⓁⓁⓁⓁⓁⓁⓁⓁⓁ
242410 SC	242410 SC NK	--	242410 SCGV NK	24.00 x 24.00 x 10.00	610 x 610 x 254		14	ⓀⓁⓁⓁⓁⓁⓁⓁⓁⓁⓁ	ⓀⓁⓁⓁⓁⓁⓁⓁⓁⓁⓁ
--	302410 SC NK	--	302410 SCGV NK	30.00 x 24.00 x 10.00	762 x 610 x 254		14	--	--
--	303010 SC NK	--	303010 SCGV NK	30.00 x 30.00 x 10.00	762 x 762 x 254		14	--	--
--	362410 SC NK	--	362410 SCGV NK	36.00 x 24.00 x 10.00	914 x 610 x 254		14	--	--
--	363610 SC NK	--	363610 SCGV NK	36.00 x 36.00 x 10.00	914 x 914 x 254		12	--	--
--	121212 SC NK	--	121212 SCGV NK	12.00 x 12.00 x 12.00	305 x 305 x 305		16	--	--
181812 SC	181812 SC NK	--	181812 SCGV NK	18.00 x 18.00 x 12.00	457 x 457 x 305		16	ⓀⓁⓁⓁⓁⓁⓁⓁⓁⓁⓁ	ⓀⓁⓁⓁⓁⓁⓁⓁⓁⓁⓁ
241212 SC	241212 SC NK	--	241212 SCGV NK	24.00 x 12.00 x 12.00	610 x 305 x 305		16	ⓀⓁⓁⓁⓁⓁⓁⓁⓁⓁⓁ	ⓁⓁⓁⓁⓁⓁ
241812 SC	241812 SC NK	--	241812 SCGV NK	24.00 x 18.00 x 12.00	610 x 457 x 305		16	ⓀⓁⓁⓁⓁⓁⓁⓁⓁⓁⓁ	ⓀⓁⓁⓁⓁⓁⓁⓁⓁⓁⓁ
242412 SC	242412 SC NK	--	242412 SCGV NK	24.00 x 24.00 x 12.00	610 x 610 x 305		14	ⓀⓁⓁⓁⓁⓁⓁⓁⓁⓁⓁ	ⓀⓁⓁⓁⓁⓁⓁⓁⓁⓁⓁ
302412 SC	302412 SC NK	--	302412 SCGV NK	30.00 x 24.00 x 12.00	762 x 610 x 305		14	ⓀⓁⓁⓁⓁⓁⓁⓁⓁⓁⓁ	ⓀⓁⓁⓁⓁⓁⓁⓁⓁⓁⓁ
--	303012 SC NK	--	303012 SCGV NK	30.00 x 30.00 x 12.00	762 x 762 x 305		12	--	--
362412 SC	362412 SC NK	--	362412 SCGV NK	36.00 x 24.00 x 12.00	914 x 610 x 305		14	ⓀⓁⓁⓁⓁⓁⓁⓁⓁⓁⓁ	ⓀⓁⓁⓁⓁⓁⓁⓁⓁⓁⓁ
--	363612 SC NK	--	363612 SCGV NK	48.00 x 48.00 x 12.00	1219 x 1219 x 305		12	--	--
--	484812 SC NK	--	484812 SCGV NK	48.00 x 48.00 x 12.00	1219 x 1219 x 305		12	--	--
--	303016 SC NK	--	--	30.00 x 30.00 x 16.00	762 x 762 x 406		12	--	--
--	363616 SC NK	--	363616 SCGV NK	48.00 x 48.00 x 16.00	1219 x 1219 x 406		12	--	--
--	484816 SC NK	--	484816 SCGV NK	48.00 x 48.00 x 16.00	1219 x 1219 x 405		12	--	--

Type 1, 3, & 3R Enclosures

## Type 1 Flush & Surface Covers - Painted & Galvanized

Catalog Number

Subclass: ANO - Painted & AX1 - Galvanized

Optional Flush Covers		Flush Cover Size		Fits Enclosure			Replacement Surface Covers		Surface Cover Size		Fits Enclosure			
Catalog Number				A x B			Catalog Number				A x B			
Painted	Galvanized	in.	mm	in.	mm		Gauge	Painted	Galvanized	in.	mm	in.	mm	Gauge
44 SCF	--	5.50 x 5.50	140 x 140	4.00 x 4.00	102 x 102		16	--	--	--	--	--	--	--
66 SCF	--	7.50 x 7.50	191 x 191	6.00 x 6.00	152 x 152		16	66 SCS	--	6.09 x 6.09	155 x 155	6.00 x 6.00	152 x 152	16
86 SCF	--	9.50 x 7.50	241 x 191	8.00 x 6.00	203 x 152		16	--	--	--	--	--	--	--
88 SCF	--	9.50 x 9.50	241 x 241	8.00 x 8.00	203 x 203		16	88 SCS	--	8.09 x 8.09	205 x 205	8.00 x 8.00	203 x 203	16
108 SCF	--	11.50 x 9.50	292 x 241	10.00 x 8.00	254 x 203		16	--	--	--	--	--	--	--
1010 SCF	--	11.50 x 11.50	292 x 292	10.00 x 10.00	254 x 254		16	1010 SCS	--	10.09 x 10.09	256 x 256	10.00 x 10.00	254 x 254	16
128 SCF	--	13.50 x 11.50	343 x 241	12.00 x 8.00	305 x 203		16	--	--	--	--	--	--	--
1212 SCF	--	13.50 x 13.50	343 x 343	12.00 x 12.00	305 x 305		16	1212 SCS	--	12.09 x 12.09	307 x 307	12.00 x 12.00	305 x 305	16
1616 SCF	--	17.50 x 17.50	445 x 445	16.00 x 16.00	406 x 406		14	--	--	--	--	--	--	--
1812 SCF	--	19.50 x 13.50	495 x 343	18.00 x 12.00	457 x 305		14	--	--	--	--	--	--	--
1818 SCF	--	19.50 x 19.50	495 x 495	18.00 x 18.00	457 x 457		14	1818 SCS	--	18.09 x 18.09	459 x 459	18.00 x 18.00	457 x 457	16
2418 SCF	--	25.50 x 19.50	648 x 495	24.00 x 18.00	610 x 457		12	--	--	--	--	--	--	--
2424 SCF	--	25.50 x 24.50	648 x 622	24.00 x 24.00	610 x 610		12	2424 SCS	--	24.09 x 24.09	612 x 612	24.00 x 24.00	610 x 610	14

Notes: Dimensions are in inches. Millimeters shown are for reference only. Data subject to change without notice.

# Type 1, 3, & 3R Enclosures

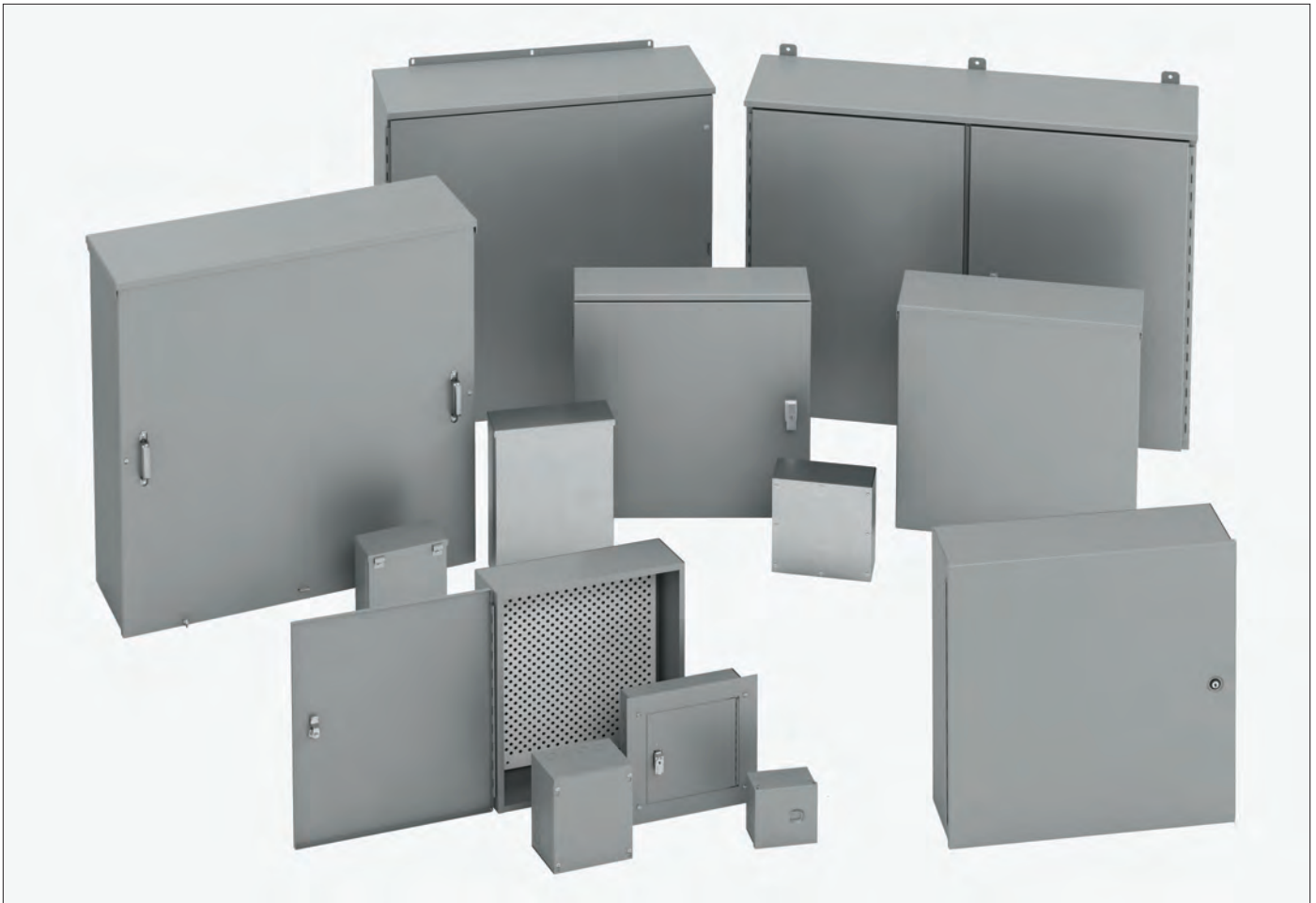

Type 1, 3, & 3R Enclosures

Junction Boxes Type 1 Screw Cover .....	50-53
Junction Boxes Type 1 Hinge Cover .....	54-55
Junction Boxes Type 3R Screw Cover .....	56-57
Junction Boxes Type 3R Hinge Cover .....	58-59
Junction Boxes Type 3 Screw Cover Gasketed .....	60-61
Junction Boxes Type 3 Weatherproof Screw Cover .....	62-63
Panel Enclosures Type 1 Small .....	64-65
Panel Enclosures Type 1 Medium .....	66-67
Panel Enclosures Type 1 Large .....	68-69
Panel Enclosures Type 1 Locking Hinge Cover w/Perforated Panel .....	70-71
Panel Enclosures Type 3R Small Continuous Hinge Cover .....	72-73
Panel Enclosures Type 3R Large Continuous Hinge Cover .....	74-75
Panel Enclosures Type 3R Double-Door .....	76-77
Utility Cabinets Type 1 Telephone Cabinets .....	78-80
Utility Cabinets Type 3R Telephone Cabinets .....	81-82
Utility Cabinets Type 3R Screw Cover Current Transformer Cabinets .....	83-85
Utility Cabinets Type 3R Hinge Cover Current Transformer Cabinets .....	86-87

# Type 1, 3, & 3R Enclosures

## Junction Boxes Type 1 Screw Cover - Painted & Galvanized Data and Illustration Sheet

Type 1, 3, & 3R Enclosures

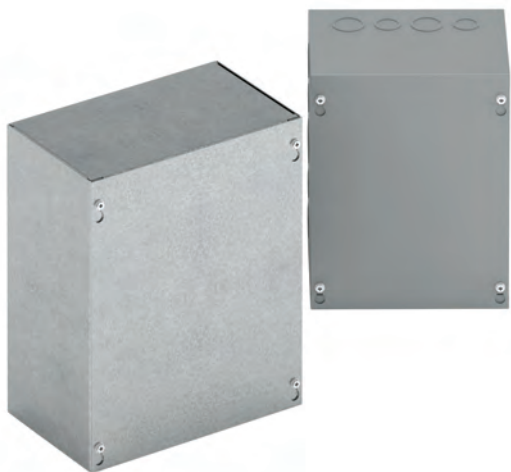

### Application

- Used as wiring boxes, junction and pull boxes
- Protects against contact with enclosed equipment

### Standards

- UL 50 listed, Type 1
- CSA C22.2 No. 40 certified, Type 1
- Conforms to NEMA standard for Type 1

### Finish

- Wash and phosphate undercoat or galvanized steel
- ANSI 61 gray acrylic electrocoat finish

### Accessories

- Ground lug kit
- Touch-up paint
- See Accessories section

### Construction

- Enclosure and cover are fabricated from code gauge steel or galvanized steel, (see table)
- Enclosure body has mounting holes on the back
- Enclosures are available with or without knockouts on the sides, top and bottom ends
- Cover is secured to the body with plated pan head combo screws
- Keyhole slots provided in the cover allow easy access to the inside without removing the screws
- Hole provision for optional ground lug kit
- Ground screw provided

### Discount Schedule: A2

### Subclass: AN0 (painted) & AX1 (galvanized)

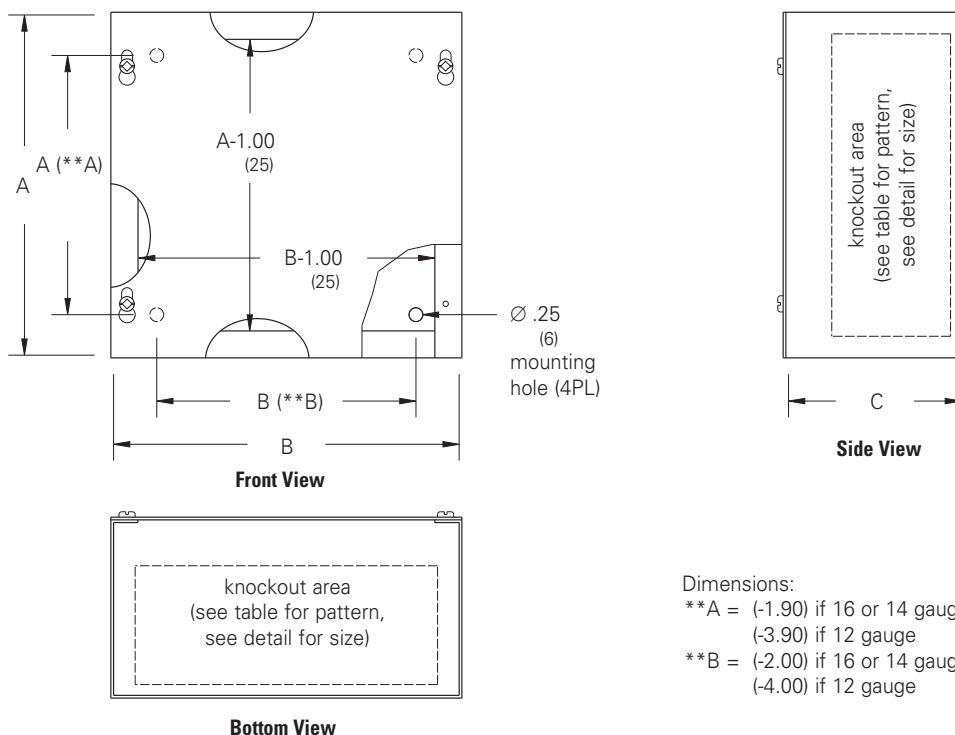

**Notes:** We can provide special sizes, finishes and other modifications. Consult the factory for your special requirements. Dimensions are in inches. Millimeters shown are for reference only. Data subject to change without notice.

## Junction Boxes Type 1 Screw Cover - Painted & Galvanized

Catalog Number

Subclass: ANO - Painted & AX1 - Galvanized

Enclosure Catalog Number				Enclosure Size		Gauge	Knockout Pattern	Knockout Pattern
Painted		Galvanized		Height x Width x Depth				
KO	No KO	KO	No KO	in.	mm		Each Side	Top & Bottom
443 SC	443 SC NK	443 SCGV	443 SCGV NK	4.00 x 4.00 x 3.00	102 x 102 x 76	16	(C D)	(C D)
444 SC	444 SC NK	444 SCGV	444 SCGV NK	4.00 x 4.00 x 4.00	102 x 102 x 102	16	(C D)	(C D)
644 SC	644 SC NK	644 SCGV	644 SCGV NK	6.00 x 4.00 x 4.00	152 x 102 x 102	16	(C D E)	(C D)
663 SC	663 SC NK	663 SCGV	663 SCGV NK	6.00 x 6.00 x 3.00	152 x 152 x 76	16	(C D E)	(C D E)
664 SC	664 SC NK	664 SCGV	664 SCGV NK	6.00 x 6.00 x 4.00	152 x 152 x 102	16	(C D E)	(C D E)
863 SC	863 SC NK	863 SCGV	863 SCGV NK	8.00 x 6.00 x 4.300	203 x 152 x 76	16	(G H I J)	(C D E)
864 SC	864 SC NK	864 SCGV	864 SCGV NK	8.00 x 6.00 x 4.00	203 x 152 x 102	16	(G H I J)	(C D E)
884 SC	884 SC NK	884 SCGV	884 SCGV NK	8.00 x 8.00 x 4.00	203 x 203 x 102	16	(G H I J)	(G H I J)
--	1064 SC NK	--	1064 SCGV NK	10.00 x 6.00 x 4.00	254 x 152 x 102	16	--	--
1084 SC	1084 SC NK	1084 SCGV	1084 SCGV NK	10.00 x 8.00 x 4.00	254 x 203 x 102	16	(G H I J)	(G H I J)
10104 SC	10104 SC NK	10104 SCGV	10104 SCGV NK	10.00 x 10.00 x 4.00	254 x 254 x 102	16	(G H I J)	(G H I J)
1264 SC	1264 SC NK	--	1264 SCGV NK	12.00 x 6.00 x 4.00	305 x 152 x 102	16	(D E F G H)	(C D E)
1284 SC	1284 SC NK	1284 SCGV	1284 SCGV NK	12.00 x 8.00 x 4.00	305 x 203 x 102	16	(D E F G H)	(G H I J)
12104 SC	12104 SC NK	12104 SCGV	12104 SCGV NK	12.00 x 10.00 x 4.00	305 x 254 x 102	16	(D E F G H)	(D E F G H)
12124 SC	12124 SC NK	12124 SCGV	12124 SCGV NK	12.00 x 12.00 x 4.00	305 x 305 x 102	16	(D E F G H)	(D E F G H)
--	15154 SC NK	15154 SCGV	--	15.00 x 15.00 x 4.00	381 x 381 x 102	16	(C D E F G H I)	(C D E F G H I)
16124 SC	16124 SC NK	16124 SCGV	16124 SCGV NK	16.00 x 12.00 x 4.00	406 x 305 x 102	16	(C D E F G H I)	(D E F G H)
16164 SC	16164 SC NK	16164 SCGV	--	16.00 x 16.00 x 4.00	406 x 406 x 102	16	(C D E F G H I)	(C D E F G H I)
18124 SC	18124 SC NK	18124 SCGV	18124 SCGV NK	18.00 x 12.00 x 4.00	457 x 305 x 102	16	(B C D E F G H I J)	(D E F G H)
--	18154 SC NK	18154 SCGV	--	18.00 x 15.00 x 4.00	457 x 381 x 102	16	(B C D E F G H I J)	(C D E F G H I)
18184 SC	18184 SC NK	18184 SCGV	18184 SCGV NK	18.00 x 18.00 x 4.00	457 x 457 x 102	16	(B C D E F G H I J)	(B C D E F G H I J)
24124 SC	24124 SC NK	24124 SCGV	--	24.00 x 12.00 x 4.00	610 x 305 x 102	16	(B C D E F G H I J)	(D E F G H)
--	24184 SC NK	24184 SCGV	--	24.00 x 18.00 x 4.00	610 x 457 x 102	16	(B C D E F G H I J)	(B C D E F G H I J)
24244 SC	24244 SC NK	24244 SCGV	24244 SCGV NK	24.00 x 24.00 x 4.00	610 x 610 x 102	14	(B C D E F G H I J)	(B C D E F G H I J)
--	30184 SC NK	30184 SCGV	30184 SCGV NK	30.00 x 18.00 x 4.00	762 x 457 x 102	16	(B C D E F G H I J)	(B C D E F G H I J)
30244 SC	30244 SC NK	30244 SCGV	30244 SCGV NK	30.00 x 24.00 x 4.00	762 x 610 x 102	14	(B C D E F G H I J)	(B C D E F G H I J)
-	30304 SC NK	-	30304 SCGV NK	30.00 x 30.00 x 4.00	762 x 762 x 102	12	--	--

Type 1, 3, & 3R Enclosures

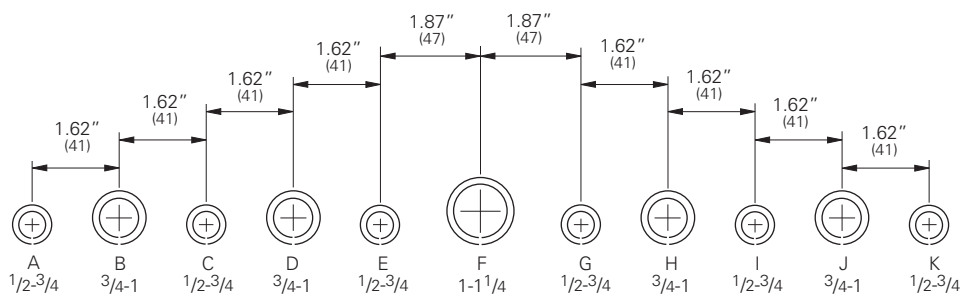

### Conduit Sizes

### Knockout Detail

Note: See table for applicable knockout pattern.

Notes: Dimensions are in inches. Millimeters shown are for reference only. Data subject to change without notice.



# Type 1, 3, & 3R Enclosures

## Junction Boxes

### Type 1 Screw Cover - Painted & Galvanized

Catalog Number

Subclass: ANO - Painted & AX1 - Galvanized

Type 1, 3, & 3R Enclosures

Enclosure Catalog Number				Enclosure Size		Gauge	Knockout Pattern	Knockout Pattern
Painted		Galvanized		Height x Width x Depth				
KO	No KO	KO	No KO	in.	mm			
666 SC	666 SC NK	666 SCGV	666 SCGV NK	6.00 x 6.00 x 6.00	152 x 152 x 152	16	(CDE)	(CDE)
866 SC	866 SC NK	866 SCGV	866 SCGV NK	8.00 x 6.00 x 6.00	203 x 152 x 152	16	(GHIJ)	(CDE)
886 SC	886 SC NK	886 SCGV	886 SCGV NK	8.00 x 8.00 x 6.00	203 x 203 x 152	16	(GHIJ)	(GHIJ)
1086 SC	1086 SC NK	1086 SCGV	1086 SCGV NK	10.00 x 8.00 x 6.00	254 x 203 x 152	16	(DEFGH)	(GHIJ)
10106 SC	10106 SC NK	10106 SCGV	10106 SCGV NK	10.00 x 10.00 x 6.00	254 x 254 x 152	16	(DEFGH)	(DEFGH)
--	1266 SC NK	--	--	12.00 x 6.00 x 6.00	305 x 152 x 152	16	--	--
--	1286 SC NK	--	1286 SCGV NK	12.00 x 8.00 x 6.00	305 x 203 x 152	16	--	--
12106 SC	12106 SC NK	12106 SCGV	12106 SCGV NK	12.00 x 10.00 x 6.00	305 x 254 x 152	16	(DEFGH)	(DEFGH)
12126 SC	12126 SC NK	12126 SCGV	12126 SCGV NK	12.00 x 12.00 x 6.00	305 x 305 x 152	16	(DEFGH)	(DEFGH)
--	15156 SC NK	--	15156 SCGV NK	15.00 x 15.00 x 6.00	381 x 381 x 152	16	--	--
16126 SC	16126 SC NK	16126 SCGV	16126 SCGV NK	16.00 x 12.00 x 6.00	406 x 305 x 152	16	(CDEFGHI)	(DEFGH)
16166 SC	16166 SC NK	16166 SCGV	16166 SCGV NK	16.00 x 16.00 x 6.00	406 x 406 x 152	16	(CDEFGHI)	(BCDEFGHIJ)
18126 SC	18126 SC NK	18126 SCGV	18126 SCGV NK	18.00 x 12.00 x 6.00	457 x 305 x 152	16	(BCDEFGHIJ)	(DEFGH)
--	18156 SC NK	--	18156 SCGV NK	18.00 x 15.00 x 6.00	457 x 381 x 152	16	--	--
18186 SC	18186 SC NK	18186 SCGV	18186 SCGV NK	18.00 x 18.00 x 6.00	457 x 457 x 152	16	(BCDEFGHIJ)	(BCDEFGHIJ)
--	24126 SC NK	--	24126 SCGV NK	24.00 x 12.00 x 6.00	610 x 305 x 152	16	--	--
24186 SC	24186 SC NK	24186 SCGV	24186 SCGV NK	24.00 x 18.00 x 6.00	610 x 457 x 152	16	(BCDEFGHIJ)	(BCDEFGHIJ)
--	24206 SC NK	--	24206 SCGV NK	24.00 x 20.00 x 6.00	610 x 508 x 152	14	--	--
24246 SC	24246 SC NK	24246 SCGV	24246 SCGV NK	24.00 x 24.00 x 6.00	610 x 610 x 152	14	(BCDEFGHIJ)	(BCDEFGHIJ)
--	30186 SC NK	--	30186 SCGV NK	30.00 x 18.00 x 6.00	762 x 457 x 152	16	--	--
30246 SC	30246 SC NK	30246 SCGV	30246 SCGV NK	30.00 x 24.00 x 6.00	762 x 610 x 152	14	(BCDEFGHIJ)	(BCDEFGHIJ)
--	30306 SC NK	--	30306 SCGV NK	30.00 x 30.00 x 6.00	762 x 762 x 152	12	--	--
36246 SC	36246 SC NK	--	36246 SCGV NK	36.00 x 24.00 x 6.00	914 x 310 x 152	14	(BCDEFGHIJ)	(BCDEFGHIJ)
--	36306 SC NK	--	36306 SCGV NK	36.00 x 30.00 x 6.00	914 x 762 x 152	12	--	--
--	36366 SC NK	--	36366 SCGV NK	36.00 x 36.00 x 6.00	914 x 914 x 152	12	--	--
--	48366 SC NK	--	48366 SCGV NK	48.00 x 36.00 x 6.00	1219 x 914 x 152	12	--	--
--	48486 SC NK	--	48486 SCGV NK	48.00 x 48.00 x 6.00	1219 x 1219 x 152	12	--	--
888 SC	888 SC NK	888 SCGV	888 SCGV NK	8.00 x 8.00 x 8.00	203 x 203 x 203	16	(GHIJ)	(GHIJ)
--	10108 SC NK	--	10108 SCGV NK	10.00 x 10.00 x 8.00	254 x 254 x 203	16	--	--
12128 SC	12128 SC NK	--	12128 SCGV NK	12.00 x 12.00 x 8.00	305 x 305 x 203	16	(DEFGH)	(DEFGH)
16128 SC	16128 SC NK	--	16128 SCGV NK	16.00 x 12.00 x 8.00	406 x 305 x 203	16	(CDEFGHI)	(DEFGH)
18128 SC	18128 SC NK	--	18128 SCGV NK	18.00 x 12.00 x 8.00	457 x 305 x 203	16	(BCDEFGHIJ)	(DEFGH)
18188 SC	18188 SC NK	--	18188 SCGV NK	18.00 x 18.00 x 8.00	457 x 457 x 203	16	(BCDEFGHIJ)	(BCDEFGHIJ)
24128 SC	24128 SC NK	--	24128 SCGV NK	24.00 x 12.00 x 8.00	610 x 305 x 203	16	(BCDEFGHIJ)	(DEFGH)
24188 SC	24188 SC NK	--	24188 SCGV NK	24.00 x 18.00 x 8.00	610 x 457 x 203	16	(BCDEFGHIJ)	(BCDEFGHIJ)
--	24208 SC NK	--	24208 SCGV NK	24.00 x 20.00 x 8.00	610 x 508 x 203	14	--	--
24248 SC	24248 SC NK	--	24248 SCGV NK	24.00 x 24.00 x 8.00	610 x 610 x 203	14	(BCDEFGHIJ)	(BCDEFGHIJ)
30248 SC	30248 SC NK	30248 SCGV	30248 SCGV NK	30.00 x 24.00 x 8.00	762 x 610 x 203	14	(BCDEFGHIJ)	(BCDEFGHIJ)
--	30308 SC NK	--	30308 SCGV NK	30.00 x 30.00 x 8.00	762 x 762 x 203	12	--	--
36248 SC	36248 SC NK	--	36248 SCGV NK	36.00 x 24.00 x 8.00	914 x 610 x 203	14	(BCDEFGHIJ)	(BCDEFGHIJ)
--	36308 SC NK	--	36308 SCGV NK	36.00 x 30.00 x 8.00	914 x 762 x 203	14	--	--
--	36368 SC NK	--	36368 SCGV NK	36.00 x 36.00 x 8.00	914 x 914 x 203	14	--	--

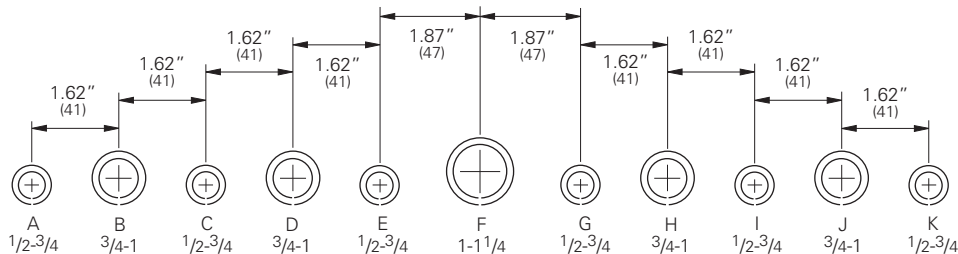

**Conduit Sizes Knockout Detail** - Note: See table for applicable knockout pattern.

**Notes:** Dimensions are in inches. Millimeters shown are for reference only. Data subject to change without notice.

## Junction Boxes Type 1 Screw Cover - Painted & Galvanized

Catalog Number

Subclass: ANO - Painted & AX1 - Galvanized

Enclosure Catalog Number				Enclosure Size			Gauge	Knockout Pattern	Knockout Pattern
Painted		Galvanized		Height x Width x Depth A x B x C				Each Side	Top & Bottom
KO	No KO	KO	No KO	in.	mm				
--	121210 SC NK	--	121210 SCGV NK	12.00 x 12.00 x 10.00	305 x 305 x 254		16	--	--
181810 SC	181210 SC NK	--	181210 SCGV NK	18.00 x 12.00 x 10.00	457 x 305 x 254		16	ⓀⓁⓂⓎⓌⓏⓉⓈⓇⓆⓅⓄⓃ	ⓀⓁⓂⓎⓌⓏⓉⓈⓇⓆⓅⓄⓃ
181810 SC	181810 SC NK	--	181810 SCGV NK	18.00 x 18.00 x 10.00	457 x 457 x 254		16	ⓀⓁⓂⓎⓌⓏⓉⓈⓇⓆⓅⓄⓃ	ⓀⓁⓂⓎⓌⓏⓉⓈⓇⓆⓅⓄⓃ
--	241210 SC NK	--	241210 SCGV NK	24.00 x 12.00 x 10.00	610 x 305 x 254		16	--	--
241810 SC	241810 SC NK	--	241810 SCGV NK	24.00 x 18.00 x 10.00	610 x 457 x 254		16	ⓀⓁⓂⓎⓌⓏⓉⓈⓇⓆⓅⓄⓃ	ⓀⓁⓂⓎⓌⓏⓉⓈⓇⓆⓅⓄⓃ
242410 SC	242410 SC NK	--	242410 SCGV NK	24.00 x 24.00 x 10.00	610 x 610 x 254		14	ⓀⓁⓂⓎⓌⓏⓉⓈⓇⓆⓅⓄⓃ	ⓀⓁⓂⓎⓌⓏⓉⓈⓇⓆⓅⓄⓃ
--	302410 SC NK	--	302410 SCGV NK	30.00 x 24.00 x 10.00	762 x 610 x 254		14	--	--
--	303010 SC NK	--	303010 SCGV NK	30.00 x 30.00 x 10.00	762 x 762 x 254		14	--	--
--	362410 SC NK	--	362410 SCGV NK	36.00 x 24.00 x 10.00	914 x 610 x 254		14	--	--
--	363610 SC NK	--	363610 SCGV NK	36.00 x 36.00 x 10.00	914 x 914 x 254		12	--	--
--	121212 SC NK	--	121212 SCGV NK	12.00 x 12.00 x 12.00	305 x 305 x 305		16	--	--
181812 SC	181812 SC NK	--	181812 SCGV NK	18.00 x 18.00 x 12.00	457 x 457 x 305		16	ⓀⓁⓂⓎⓌⓏⓉⓈⓇⓆⓅⓄⓃ	ⓀⓁⓂⓎⓌⓏⓉⓈⓇⓆⓅⓄⓃ
241212 SC	241212 SC NK	--	241212 SCGV NK	24.00 x 12.00 x 12.00	610 x 305 x 305		16	ⓀⓁⓂⓎⓌⓏⓉⓈⓇⓆⓅⓄⓃ	ⓀⓁⓂⓎⓌⓏⓉⓈⓇⓆⓅⓄⓃ
241812 SC	241812 SC NK	--	241812 SCGV NK	24.00 x 18.00 x 12.00	610 x 457 x 305		16	ⓀⓁⓂⓎⓌⓏⓉⓈⓇⓆⓅⓄⓃ	ⓀⓁⓂⓎⓌⓏⓉⓈⓇⓆⓅⓄⓃ
242412 SC	242412 SC NK	--	242412 SCGV NK	24.00 x 24.00 x 12.00	610 x 610 x 305		14	ⓀⓁⓂⓎⓌⓏⓉⓈⓇⓆⓅⓄⓃ	ⓀⓁⓂⓎⓌⓏⓉⓈⓇⓆⓅⓄⓃ
302412 SC	302412 SC NK	--	302412 SCGV NK	30.00 x 24.00 x 12.00	762 x 610 x 305		14	ⓀⓁⓂⓎⓌⓏⓉⓈⓇⓆⓅⓄⓃ	ⓀⓁⓂⓎⓌⓏⓉⓈⓇⓆⓅⓄⓃ
--	303012 SC NK	--	303012 SCGV NK	30.00 x 30.00 x 12.00	762 x 762 x 305		12	--	--
362412 SC	362412 SC NK	--	362412 SCGV NK	36.00 x 24.00 x 12.00	914 x 610 x 305		14	ⓀⓁⓂⓎⓌⓏⓉⓈⓇⓆⓅⓄⓃ	ⓀⓁⓂⓎⓌⓏⓉⓈⓇⓆⓅⓄⓃ
--	363612 SC NK	--	363612 SCGV NK	48.00 x 48.00 x 12.00	1219 x 1219 x 305		12	--	--
--	484812 SC NK	--	484812 SCGV NK	48.00 x 48.00 x 12.00	1219 x 1219 x 305		12	--	--
--	303016 SC NK	--	--	30.00 x 30.00 x 16.00	762 x 762 x 406		12	--	--
--	363616 SC NK	--	363616 SCGV NK	48.00 x 48.00 x 16.00	1219 x 1219 x 406		12	--	--
--	484816 SC NK	--	484816 SCGV NK	48.00 x 48.00 x 16.00	1219 x 1219 x 405		12	--	--

Type 1, 3, & 3R Enclosures

## Type 1 Flush & Surface Covers - Painted & Galvanized

Catalog Number

Subclass: ANO - Painted & AX1 - Galvanized

Optional Flush Covers		Flush Cover Size		Fits Enclosure			Replacement Surface Covers		Surface Cover Size		Fits Enclosure			
Catalog Number				A x B			Catalog Number				A x B			
Painted	Galvanized	in.	mm	in.	mm		Gauge	Painted	Galvanized	in.	mm	in.	mm	Gauge
44 SCF	--	5.50 x 5.50	140 x 140	4.00 x 4.00	102 x 102		16	--	--	--	--	--	--	--
66 SCF	--	7.50 x 7.50	191 x 191	6.00 x 6.00	152 x 152		16	66 SCS	--	6.09 x 6.09	155 x 155	6.00 x 6.00	152 x 152	16
86 SCF	--	9.50 x 7.50	241 x 191	8.00 x 6.00	203 x 152		16	--	--	--	--	--	--	--
88 SCF	--	9.50 x 9.50	241 x 241	8.00 x 8.00	203 x 203		16	88 SCS	--	8.09 x 8.09	205 x 205	8.00 x 8.00	203 x 203	16
108 SCF	--	11.50 x 9.50	292 x 241	10.00 x 8.00	254 x 203		16	--	--	--	--	--	--	--
1010 SCF	--	11.50 x 11.50	292 x 292	10.00 x 10.00	254 x 254		16	1010 SCS	--	10.09 x 10.09	256 x 256	10.00 x 10.00	254 x 254	16
128 SCF	--	13.50 x 11.50	343 x 241	12.00 x 8.00	305 x 203		16	--	--	--	--	--	--	--
1212 SCF	--	13.50 x 13.50	343 x 343	12.00 x 12.00	305 x 305		16	1212 SCS	--	12.09 x 12.09	307 x 307	12.00 x 12.00	305 x 305	16
1616 SCF	--	17.50 x 17.50	445 x 445	16.00 x 16.00	406 x 406		14	--	--	--	--	--	--	--
1812 SCF	--	19.50 x 13.50	495 x 343	18.00 x 12.00	457 x 305		14	--	--	--	--	--	--	--
1818 SCF	--	19.50 x 19.50	495 x 495	18.00 x 18.00	457 x 457		14	1818 SCS	--	18.09 x 18.09	459 x 459	18.00 x 18.00	457 x 457	16
2418 SCF	--	25.50 x 19.50	648 x 495	24.00 x 18.00	610 x 457		12	--	--	--	--	--	--	--
2424 SCF	--	25.50 x 24.50	648 x 622	24.00 x 24.00	610 x 610		12	2424 SCS	--	24.09 x 24.09	612 x 612	24.00 x 24.00	610 x 610	14

Notes: Dimensions are in inches. Millimeters shown are for reference only. Data subject to change without notice.