

THIS ITEM IS FABRICATED AND AS SUCH MAY HAVE VARYING DIMENSIONS DUE TO DIFFERENT MANUFACTURING PROCESSES		
DIMENSIONS SHOWN ARE FOR REFERENCE AND ARE SUBJECT TO CHANGE WITHOUT NOTICE		
Kraloy, a Division of Multi Fittings Corp. under license		
<i>PART DESCRIPTION</i> 80STD3090 3"x90D PVC STD ELBOW SPxSP SCH80 KRALOY		
<i>PRODUCT CODE:</i> 078627	<i>UNIT: INCHES UNLESS</i> <i>DUAL DIMENSION: INCH [METRIC]</i>	<i>SCALE:</i> NTS
<i>DRAWN:</i> A.R.		

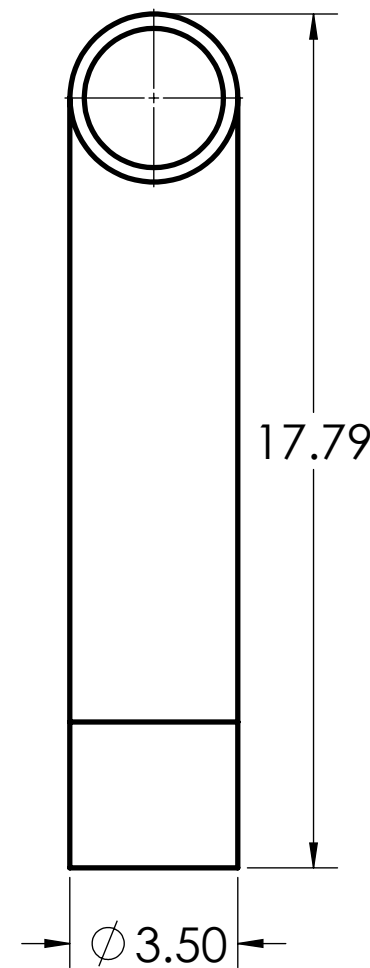
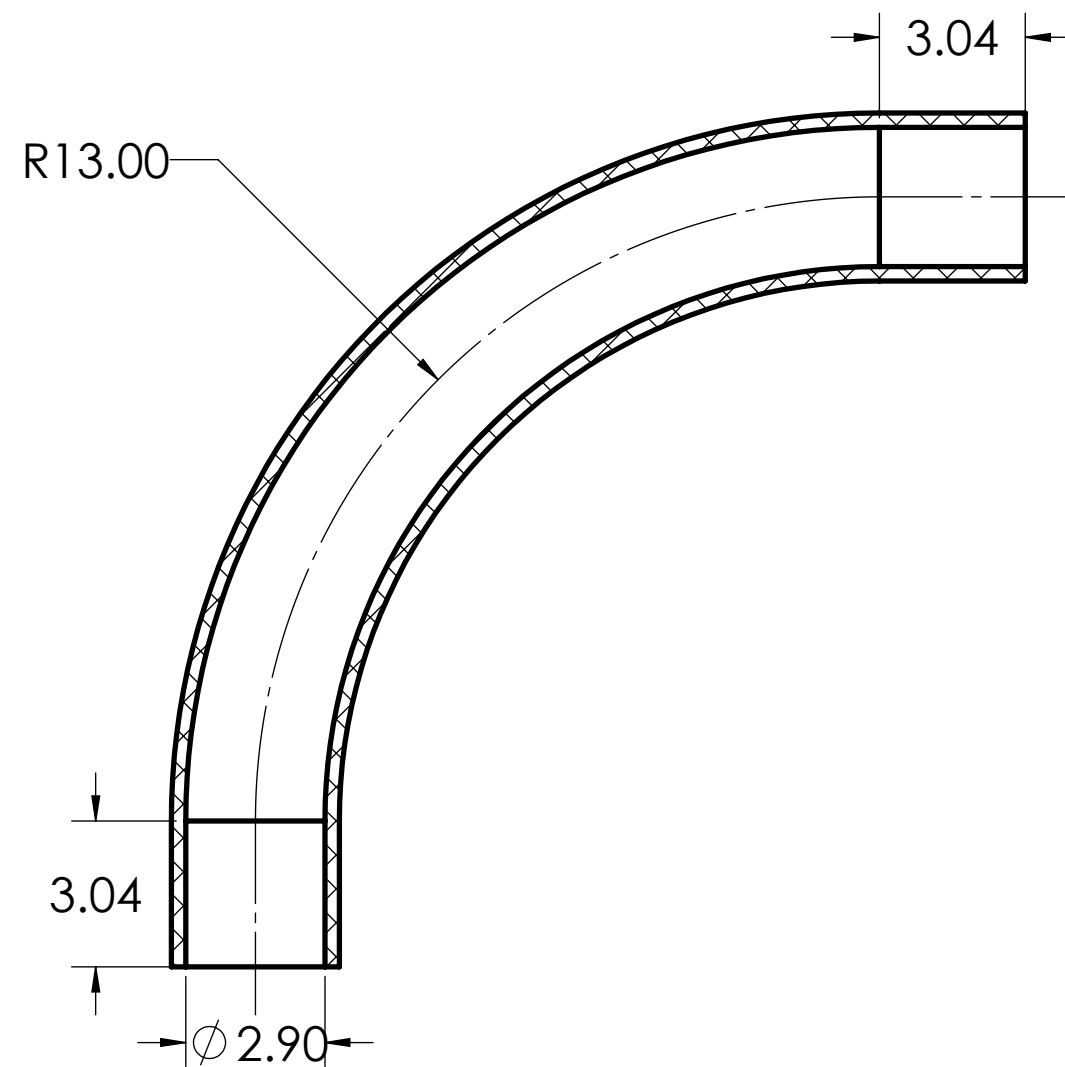
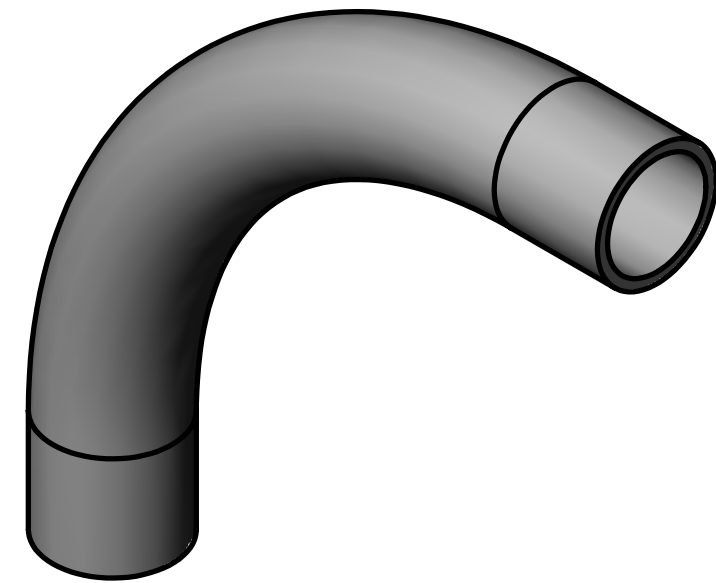
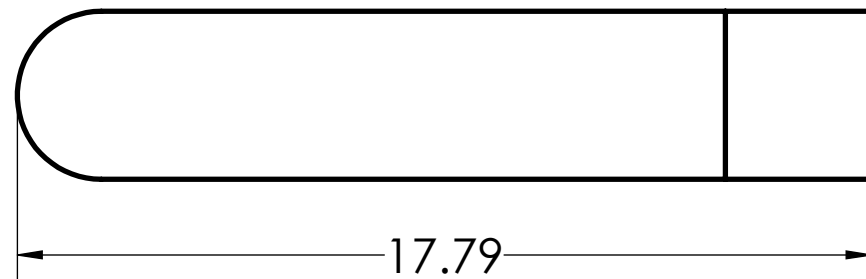

THIS ITEM IS FABRICATED AND AS SUCH MAY HAVE VARYING DIMENSIONS DUE TO DIFFERENT MANUFACTURING PROCESSES		
DIMENSIONS SHOWN ARE FOR REFERENCE AND ARE SUBJECT TO CHANGE WITHOUT NOTICE		
Kraloy, a Division of Multi Fittings Corp. under license		
<i>PART DESCRIPTION</i> 80STD3090 3"x90D PVC STD ELBOW SPxSP SCH80 KRALOY		
<i>PRODUCT CODE:</i> 078627	<i>UNIT: INCHES UNLESS</i> <i>DUAL DIMENSION: INCH [METRIC]</i>	<i>SCALE:</i> NTS
<i>DRAWN:</i> A.R.		