



Pocket Pro



IPEX
Committed to Excellence

www.ipexna.com

ELECTRICAL SYSTEMS

Scepter[®]
Rigid PVC Conduit & Fittings

SceptaCon[™]
Trenchless Raceways Systems

Sceptalight[™]
Nonmetallic Light Fixtures

KWIKON[®]
Electrical Nonmetallic Fittings

Scepter JBox[™]
The Next Generation Junction Box

INEXO[®]
The ICF Box

MONOBLOC[®] A
Underground Duct Spacers

SUPER DUCT[®]
Power & Communication Duct

COR-LINE[®]
Electrical Nonmetallic Tubing



TYPE DESIGNATION	UL UNDERWRITERS LABORATORIES INC (UL 50 AND UL 508)
1	Indoor use primarily to provide protection against contact with the enclosed equipment and against a limited amount of falling dirt.
2	Indoor use to provide a degree of protection against limited amounts of falling water and dirt.
3	Outdoor use to provide a degree of protection against windblown rain; undamaged by the formation of ice on the enclosure.
4	Either indoor or outdoor use to provide a degree of protection against falling rain, splashing water, and hose-directed water; undamaged by the formation of ice on the enclosure.
4X	Either indoor or outdoor use to provide a degree of protection against falling rain, splashing water, and hose-directed water; undamaged by the formation of ice on the enclosure; resists corrosion.
6P	Indoor or outdoor use primarily to provide a degree of protection against hose-directed water, the entry of water during prolonged submersion at a limited depth, and be undamaged by the formation of ice on the enclosure.
12	Indoor use to provide a degree of protection against dust, dirt, fiber flyings, dripping water, and external condensation of noncorrosive liquids.
13	Indoor use to provide a degree of protection and spraying of water, oil, and noncorrosive liquids.

This material is reproduced with permission from Underwriters Laboratories Inc. Standard for Safety for Cabinets and Boxes, UL 50, Copyright 1988 and Industrial Control Equipment, UL 508, Copyright 1994 by Underwriters Laboratories Inc.

Underwriters Laboratories Inc. (UL) shall not be responsible to anyone for the use of or reliance upon a UL Standard by anyone. UL shall not incur any obligation or liability for damages, including consequential damages, arising out of or in connection with the use, interpretation of, or reliance upon a UL Standard.

Introduction	2
Applications	3
Advantages	4
Scepter® Rigid PVC Conduit	7
Installation	8
Expansion and Contraction	10
Conduit Dimensions	15
Scepter® PVC Conduit Fitti-gs	19
Fittings	20
Cover Plates	35
Weatherproof Covers	36
Boxes	38
Scepter JBox	40
Boxes	44
Conduit Cements & Primers	49
Conduit Repair Kit	50
EPR Kits	50
EPR Kit Adapters	50
Sceptralight™: Nonmetallic Light Fixtures	51
Cor-Line® ENT & Kwikon® Fittings	59
Cor-Line Tubing	61
Dimensions	61
Kwikon Fittings	63
Kwikon Accessories	67
INEXO™	68
Super Duct®	69
Advantages/Engineering Data	70
Installation	71
Pipe	76
Fittings	77
Vertical-Lok Spacers	82
Monobloc® Spacers	84
SceptaCon™ Trenchless Raceway Systems . . .	87





Pocket Pro provides the most comprehensive information about PVC systems – from basic raw material to installation characteristics of the finished product. Written with the engineer, contractor and distributor in mind, it is based on laboratory test results and IPEX's many years of field experience.

At IPEX, we have been extruding PVC conduit and molding fittings since 1951. We formulate our own compounds, maintain strict quality control during production, and offer one of the most comprehensive lines of nonmetallic electrical products throughout North America.

More important, our commitment to customers extends beyond the sale. Quality control and thorough jobsite field reports have earned IPEX a reputation for product quality and service excellence.

Engineers, electricians, contractors, specifiers and utilities have realized for many years the advantages of PVC. Today, IPEX electrical systems include Scepter® PVC conduit and fittings, Cor-Line® ENT, FiberTel® high density polyethylene innerduct, INEXO® ICF boxes, Kwikon® ENT fittings, Monobloc® spacers, SceptaCon™ trenchless raceway systems, Sceptalight™ nonmetallic light fixtures and Super Duct® power and communication ducts. These brands are the number-one choice for power, communication and data needs. Whether exposed, concealed in walls, encased in concrete, or directly buried, IPEX electrical products are preferred *For The Long Run*.

Only when you specify IPEX branded products by name are you guaranteed our commitment to excellence.

Applications

Typical industrial/commercial and residential applications for IPEX electrical systems include:

- Utilities
- Cable
- Communications
- Street and highway lighting
- Residential applications
- Water treatment plants
- Airports
- Subways
- Sewage treatment plants
- Pulp and paper industries
- Parking garages
- Car washes
- Fish plants
- Marinas
- Agricultural, dairy, hogs, cattle, chicken, etc.
- Bridges and tunnels
- Food processing plants
- Steel mills
- Mines



Labour Savings

Compared to metal, PVC products reduce labour on a typical installation by up to two-thirds. The reason? PVC is easy to work with. It can also be cut and joined without pipe vises, cutters, threading equipment and reamers associated with metal conduit.

Lightweight Conduit

Scepter Rigid PVC Conduit is one-half the weight of aluminum and one-sixth the weight of steel. As a result, handling and installation are easier and faster, reducing labour costs.

Sunlight Resistant

The 2011 Canadian Electrical Code rule 2-130 is intended to ensure that totally enclosed nonmetallic raceways are properly protected against adverse effects from direct exposure to UV rays. Electrical nonmetallic raceways marked for such applications are suitable for installation and use in direct exposure to the rays of the sun. Scepter rigid PVC Conduit meets the criteria for sunlight resistance, is approved for the purpose, and is appropriately marked.

Easy Joining

Solvent cementing is all that is required, eliminating the need for power-threading machines, pipe vises and cutting equipment. A hacksaw or carpenter's saw is the only equipment required.

Strength

Scepter Rigid PVC Conduit offers both high impact and high tensile strength, even in cold temperatures. Scepter Rigid PVC Conduit and Fittings meet and exceed all CSA and UL standards.

Scepter Rigid PVC Conduit		CSA Impact Test	UL Impact Test
Size (in)	Size (mm)	@ -29°F (-34°C)	@ 72°F (23°C)
1/2	12	8.9 ft.lbs. (12 joules)	50 ft.lbs. (68 joules)
3/4	20	8.9 ft.lbs. (12 joules)	80 ft.lbs. (109 joules)
1	25	8.9 ft.lbs. (12 joules)	100 ft.lbs. (136 joules)
1 1/4	32	8.9 ft.lbs. (12 joules)	120 ft.lbs. (163 joules)
1 1/2	40	8.9 ft.lbs. (12 joules)	150 ft.lbs. (204 joules)
2	50	8.9 ft.lbs. (12 joules)	190 ft.lbs. (258 joules)
2 1/2	65	8.9 ft.lbs. (12 joules)	210 ft.lbs. (285 joules)
3 – 6	75 – 150	8.9 ft.lbs. (12 joules)	220 ft.lbs. (298 joules)

Easy Wire Pulls

PVC's exceptionally smooth interior surface greatly reduces the amount of friction while pulling conductors/wires through long runs, even with 90° bends. A large pull-rope and wire-pulling compound should be used when pulling all conductors and wires.

Noncorroding

PVC is immune to damage from naturally corrosive soil conditions, as well as electro-chemical and galvanic corrosion. This ensures lower maintenance costs and superior performance *For The Long Run*.

Nonconducting

Scepter Rigid PVC conduit pipe and fittings are nonsparking and nonconducting, thereby eliminating the most dangerous 'second point of contact' and 'phase to ground' faults. The use of a separate grounding conductor provides a complete and positive ground for the whole system.

Chemical Resistance

One of the greatest benefits of PVC is its excellent chemical resistance. It resists attack by acids, alkalis, salt solutions, and many other types of chemicals. For more information on PVC and chemical resistance, refer to the IPEX Chemical Resistance Guide.

Long Life

Scepter Rigid PVC Conduit pipe and fittings retain their original properties after years of exposure to heat and weather. In addition, resistance to fungi, bacterial action, rodents, termites and corrosive agents ensures a long, trouble-free life for PVC conduit installed indoors or outdoors.

Concrete Tight

Scepter Rigid PVC Conduit pipe and fittings are designed and engineered to be concrete tight in all weather conditions.



Fire Resistant

IPEX's proprietary PVC compound used to manufacture Scepter products is a self-extinguishing material and will not support combustion. Samples taken from an actual fire show the outer surface of the conduit was blistered and charred. The interior of the conduit, however, was unaffected. Additionally, the undamaged conductors were then removed and reinstalled in new conduit.

Fire-resistant characteristics when tested to CAN ULC S102.2 are as follows:

IPEX Compound	Flame Spread	Smoke Developed	Fuel Contribution
0.080" (2mm) thickness	10 – 20	225 – 270	0
0.630" (16mm) thickness	10 – 20	300 – 390	0

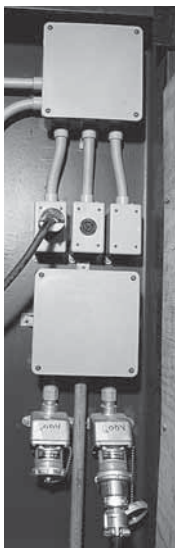

FT-4 Rating

Scepter Rigid PVC conduit is certified to meet the requirements of FT-4 allowing its use in noncombustible construction per Section 3.1.5.20 of the National Building Code, which reads:

1.) *Subject to the limits on the size of elements that penetrate fire separations as stated in Sentence 3.1.9.3.(2), within a fire compartment of a building required to be of noncombustible construction, totally enclosed nonmetallic raceways not more than 175mm in outside diameter, or of an equivalent rectangular area, are permitted to be used to enclose optical fibre cables and electrical wires and cables, provided the raceways exhibit a vertical char not more than 1.5m when tested in conformance with the Vertical Flame Test (FT - 4) Conduit or Tubing on Cable Tray in Clause 6.16 of CSA C22.2 No. 211.0, "General Requirements and Methods of Testing for Nonmetallic conduit."*

Suitable for Direct Burial

PVC is suitable for direct burial and requires no extra protection when installed in accordance with the Canadian Electrical Code and the local inspection authority guidelines. The usual care regarding trenches and backfilling should be respected.

One-Source Specification

IPEX offers a full range of PVC fittings and accessories. As a result, it is easy to specify a single source PVC system.

Quality Control

In addition to IPEX's quality control testing, all Scepter electrical products carry third-party certification by CSA, UL and NRTL.



This section covers the most comprehensive design and installation of Scepter Rigid PVC Conduit pipe and fittings. Always consult the authority having jurisdiction for specific installation procedures.



CSA C22.2 No. 211.2
CSA C22.2 No. 211.0
FT-4 for 1/2" to 6"



NEMA TC-2
Corps. of Engineers Spec.
CE 303:01
Military Spec, Federal Spec.
WC 1094A



Support

Due to PVC's light weight, support spacing is different than that used with metal conduits. Supporting straps should NOT be firmly tightened, so that linear movement of the pipe is possible. The maximum allowable support spacing, as per Canadian Electrical Code (CEC), is as follows:

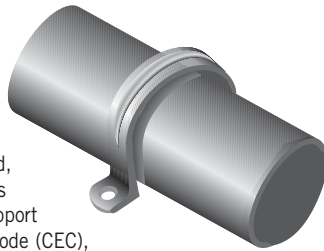

Support Spacing For Scepter Rigid PVC Conduit Pipe

Nominal Conduit Diameter		Maximum Support Spacing	
inches	mm	feet	metres
1/2	12	2-1/2	0.75
3/4	20	2-1/2	0.75
1	25	2-1/2	0.75
1-1/4	32	4	1.2
1-1/2	40	4	1.2
2	50	5	1.5
2-1/2	65	6	1.8
3	75	6	1.8
3-1/2	90	7	2.1
4	100	7	2.1
5	125	7	2.1
6	150	8	2.5

Maximum Operating Temperature

The Canadian Electrical Code (CEC) allows the use of Scepter Rigid PVC Conduit up to a maximum ambient temperature of 167°F (75°C).

Cutting

Scepter Rigid PVC conduit can be easily cut on the jobsite by using a hacksaw, carpenter's saw or PVC conduit cutters. For larger sizes of conduit, the use of a mitre box is also recommended to ensure a square cut.



Solvent Cementing

After cutting Scepter Rigid PVC conduit, sharp edges or burrs from inside the conduit should be removed with a knife. Thoroughly clean the end of the pipe and inside the fitting with a pipe cleaner. Apply a generous amount of IPEX solvent cement to both surfaces; slide together and give a quarter turn to ensure the solvent is spread evenly on the material. Hold together for a few seconds until the joint is made.

Usually the solvent-cemented joint will be strong enough to install immediately. However, in climates with low temperatures or areas with high humidity, extra time may be required before moving the pipe for permanent installation. Solvent-cemented joints appear to "set up" instantly, but will take 24 hours to cure properly. After this time, the solvent-cemented joint has completely cured and is waterproof. For extreme cold weather installations, the use of IPEX PVC Primer is recommended. IPEX cements and primers are available in quarter-pint (125ml), half-pint (250ml), pint (500ml), quart (1-litre) and gallon (4-litre) containers.



Bending

PVC is a thermoplastic material that, when heated, becomes soft and pliable. As a result, its shape can be altered.

A flameless heat source is recommended to heat the pipe. AN OPEN FLAME SHOULD NOT BE USED. Either an electric unit or an infra-red propane unit is recommended.

The necessary temperature for bending pipe is 260°F (127°C). The pipe must be heated evenly over an area approximately ten times the diameter of the pipe before any attempt at bending is made. Bending the pipe when it has not been thoroughly heated will cause the pipe to "kink." With proper care and a little practice, the bend will form easily.

Cooling the pipe with cold air or water will cause "spring back." Allow a few extra degrees of overbending to compensate. Maximum bending radius shall be six times the internal diameter according to the Canadian Electrical Code.



Using Expansion Joints

It's just as important to know when to use an expansion joint as it is to know how to install it correctly. Expansion joints are required when the temperature change is greater than 25°F (14°C). Scepter Rigid PVC conduit has a coefficient of linear expansion of 3.6×10^{-4} in./ft./°F (.054mm/m/°C.) Generally, a 100 ft. (30.48m) run of PVC conduit will undergo a change in length of 3.6 inches (91.44mm) for every 100°F (56°C) temperature change.



For conduit installed indoors, the range of expansion and contraction can be calculated using the maximum air temperature plus the heat contributed by the conductors inside the conduit and minimum air temperature expected. Expansion joints are not required indoors unless there are widely varying temperatures such as the attic of a building.

Conduit installed outdoors, exposed to direct sunlight, will be considerably hotter than the air temperature. As a guideline in this case, add 27°F (15°C) to the temperature change. Expansion joints should be installed to allow for all anticipated temperature changes.

Expansion Formula

By using the following formulas and the charts below, the total expected expansion in a run can be easily determined:

°F
 Total Expansion (in.) = length of run (ft.) x temperature change (°F) x 0.00036

or

°C
 Total Expansion (mm) = length of run (m) x temperature change (°C) x 0.054

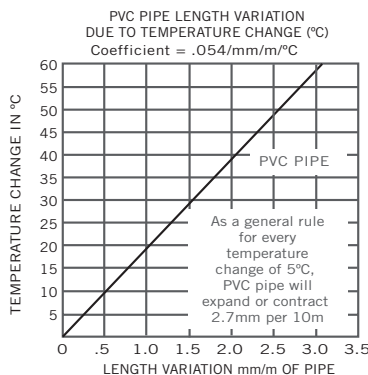
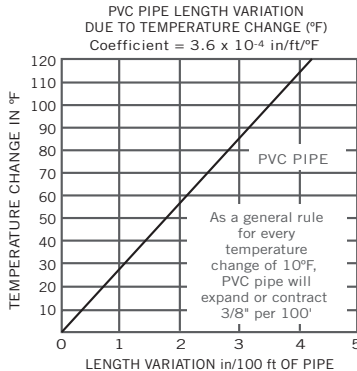

Number of Expansion Joints Required

Use the following equation to determine the number of expansion joints needed for a Scepter Rigid PVC Conduit installation:

$$\text{Number of joints} = \frac{\text{total expansion (mm or in)}}{E}$$

E = Expansion joint travel length 101.6mm (4") or 203.2mm (8") depending on diameter.

Always round up to the next whole number.

Setting the Piston Opening

The expansion joint must be installed to allow for expansion and contraction of the conduit run. On a cold day, if an expansion joint is installed completely closed with the piston bottomed, there is no room for expansion when the conduit is warmed. If it is installed open to the maximum on a hot day, the expansion joint will pull apart when cooled.

The correct piston opening for any installation condition can be easily determined using the formula below:

Piston setting =

$$\text{Compressed length} + \left(\frac{\text{max. temp.} - \text{installation temp.}}{\text{max. temp.} - \text{min. temp.}} \right) \times E$$

Formula can be used for both metric and imperial measurements.

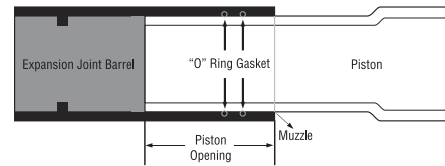

Size (mm)	Size (in)	Compressed Length (mm)	Compressed Length (in)	Travel (mm)	Travel (in)
13	1/2	203.2	8.00	101.6	4
20	3/4	203.2	8.00	101.6	4
25	1	215.9	8.50	101.6	4
32	1-1/4	228.6	9.00	101.6	4
38	1-1/2	228.6	9.00	101.6	4
51	2	235.0	9.25	101.6	4
64	2-1/2	235.0	9.25	101.6	4
76	3	362.0	14.25	203.2	8
89	3-1/2	362.0	14.25	203.2	8
102	4	362.0	14.25	203.2	8
127	5	362.0	14.25	203.2	8
152	6	362.0	14.25	203.2	8



Location of Expansion Joints

Proper functioning of an expansion joint depends on three procedures:

1. The correct placement of the expansion joint.
2. The proper installation of Scepter Rigid PVC conduit and the expansion joint.
3. The proper placement and fastening of support straps.

One Expansion Joint

Figure 1

If only one expansion joint is needed between two boxes, the barrel of the joint is rigidly fastened close to the first box. Scepter Rigid PVC conduit should then be loosely supported with straps, allowing the conduit to move freely as it expands and contracts.

Two Expansion Joints

Figure 2

If two expansion joints are needed, the joints should be firmly fastened back to back at the centre of the run. Scepter Rigid PVC conduit is loosely supported with straps, allowing the conduit to move freely as it expands and contracts.

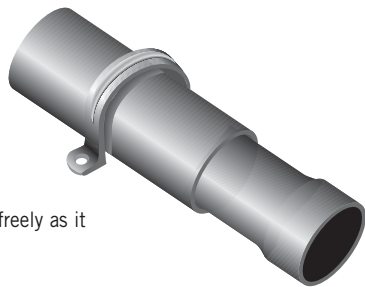

Two Expansion Joints (Alternative)

Figure 3

Alternatively, the centre of the run and the two expansion joints (located at the boxes) should be rigidly fastened. All other support straps should be loosely fastened.

Three or More Expansion Joints

Figure 4

If more than two joints are needed in a very long run, they should be put in a series, one after the other. Each barrel must be rigidly fastened while conduit is loosely supported with straps allowing the conduit to move freely as it expands and contracts. When installed in a series, each section acts independently of the other. Spacing of conduit supports must be in accordance with Section 12-1114 of the Canadian Electrical Code (CEC).

Figure 1

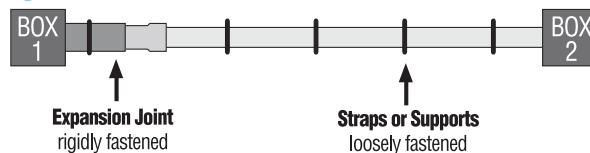

Figure 2

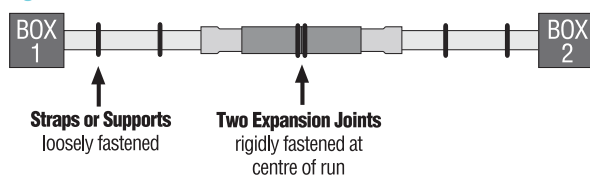

Figure 3

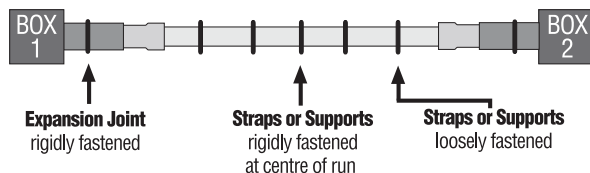
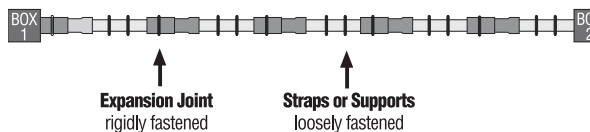

Figure 4



Installation of Expansion Joints

Installation recommendations:

- Expansion joints should be mounted so the piston can travel in a straight line in the barrel. If the alignment is not straight, the piston will bind, preventing the joint from functioning correctly.
- The expansion joint barrel should be clamped tight, but the conduit mounted loose enough in its hangers to allow for movement as it expands and contracts.
- Scepter nonmetallic straps are correctly sized and designed for proper support, and must be used to secure the conduit.
- When expansion joints are used in a vertical position, the piston should be mounted in a downward position so dirt cannot deposit between the barrel and piston at the muzzle of the expansion joints.

WARNING

Common Mistakes

Three common mistakes are:

1. Forgetting to use expansion joints.
2. Not using enough expansion joints.
3. Overtightening of support straps.

It is more cost effective to use more expansion joints than needed, rather than too few. It is difficult to correct the problem after conductors are installed and in service. Failure to accommodate expansion/contraction may result in pipe fracture.

Scepter Rigid PVC Conduit Dimensions (inches)

Nominal Size	Product Code	OD	ID	Min. Wall	Weight lbs/100'	Standard ft/crate
1/2	(10') 032105	0.840	0.622	0.109	15	6,000
	(20') 032106					12,000
3/4	(10') 032107	1.050	0.824	0.113	21	4,400
	(20') 032108					8,800
1	(10') 032110	1.315	1.049	0.133	31	3,600
	(20') 032111					7,200
1-1/4	(10') 032112	1.660	1.380	0.140	42	3,300
	(20') 032114					6,600
1-1/2	(10') 032115	1.900	1.610	0.145	53	2,250
	(20') 032116					4,500
2	(10') 032120	2.375	2.067	0.154	71	1,400
	(20') 032121					2,800
2-1/2	(10') 032125	2.875	2.469	0.203	112	780
	(20') 032126					1,560
3	(10') 032130	3.500	3.068	0.216	166	780
	(20') 032131					1,560
3-1/2	(10') 032135	4.000	3.548	0.226	200	630
	(20') 032136					1,260
4	(10') 032140	4.500	4.026	0.237	236	600
	(20') 032141					1,200
5	(10') 032150	5.563	5.047	0.258	321	230
	(20') 032151					460
6	(10') 032160	6.625	6.065	0.280	417	260
	(20') 032161					520
8	(10') 032180	8.620	7.980	0.322	559	140
	(20') 032181					280

Scepter Rigid PVC Conduit Dimensions (mm)

Nominal Size	OD	ID	Min. Wall	Weight kgs/100'
12	21.3	15.8	2.8	22.6
20	26.7	20.9	2.9	31.2
25	33.4	26.6	3.4	46.2
32	42.2	35.1	3.6	63.0
40	48.3	40.9	3.7	78.4
50	60.3	52.5	3.9	105.5
65	73.0	62.7	5.2	167.2
75	88.9	77.9	5.5	247.8
90	101.6	90.1	5.7	297.7
100	114.3	102.3	6.0	352.4
125	141.3	128.2	6.6	478.5
150	168.3	154.1	7.1	621.0
200	219.0	202.6	8.18	833.1



Weight Comparison of Scepter Rigid PVC Conduit - lbs./100 ft.

Nominal Size (in)	Rigid PVC	Aluminum	Rigid Steel
1/2	15	28	79
3/4	21	27	105
1	31	53	153
1-1/4	42	70	201
1-1/2	53	86	249
2	71	116	334
2-1/2	112	183	527
3	166	239	690
3-1/2	200	288	831
4	236	340	982
5	321	465	1,334
6	417	613	1,771
8	559		

Weight Comparison of Scepter Rigid PVC Conduit - kg/100 m

Nominal Size (in)	Rigid PVC	Aluminum	Rigid Steel
12	23	41	118
20	31	54	157
25	46	79	228
32	63	104	300
40	78	129	371
50	106	173	498
65	167	272	786
75	248	356	1,029
90	298	429	1,239
100	352	507	1,464
125	479	694	1,989
150	621	914	2,641
200	833		



CSA C22.2 No. 211.2
FT-4 for 1/2" to 6"



NEMA TC2
Corps. of Engineers Spec.
CE 303:01
Military Spec, Federal Spec.
WC 1094A

Physical properties of PVC Type II

Properties	Unit	Value	ASTM Test Method
ELECTRICAL			
Dielectric Strength	volts/mil	1215	D149
Dielectric Constant	60 cps at 30°C	3.55	D150
	1000 cps at 30°C	3.22	D150
Power Factor	60 cps at 30°C	4.04	D150
	1000 cps at 30°C	4.71	D150
PHYSICAL			
Specific Gravity		13.5	D792
Hardness	Durometer D	78	D676
Izod Impact Strength @ 73°F (23°C)	ft.lb/in. notch	15.0	D256
Tensile Strength @ 73°F (23°C)	psi	6000	D638
Compressive Strength	psi	8600	D695
Flexural Strength	psi	11500	D790
THERMAL			
Coefficient of Thermal Conductivity	BTU/sec/in ² /°F/in	0.11	C177
Coefficient of Linear Expansion	per °F x 10 ⁻⁵	5.5	D696
Heat Distortion Temperature at 264 psi	°F	158	D648
OTHERS			
Flammability		self-extinguishing	D635
Water Absorption in 30 days	%	0.6	
Color		charcoal grey	
Light Transmission		opaque	D791

All technical data is believed to be accurate and is presented solely for information and guidance.





Industry leaders specify Scepter PVC fittings by name. For years, Scepter PVC fittings have set the standard for quality and value-added features not normally available from other suppliers. Features such as our threaded brass inserts, brass screws, and superior PVC gasketing system make a real difference.



C22.2 No. 85
C22.2 No. 18.2



UL Listed
UL514B - UL514C



NEMA TC-2, 3

If you need more details about a specific product certification, please contact our customer service department.



Couplings

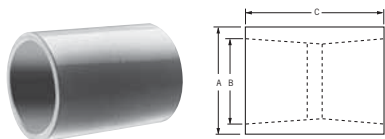

Size (in)	Part Number	Product Code	A (in)	B (in)	C (in)
1/2	EC10	077001	1.080	0.840	1.437
3/4	EC15	077002	1.300	1.050	2.200
1	EC20	077003	1.590	1.315	2.031
1-1/4	EC25	077004	2.000	1.660	2.156
1-1/2	EC30	077005	2.230	1.900	2.281
2	EC35	077006	2.720	2.375	2.406
2-1/2	EC40	077007	3.320	2.875	3.187
3	EC45	077008	4.000	3.500	3.437
3-1/2	EC50	077009	4.500	4.000	3.625
4	EC55	077010	5.000	4.500	3.750
5	EC60	077011	6.120	5.563	4.187
6	EC65	077012	7.370	6.625	4.562
8	EC70	077866			

Terminal Adapters

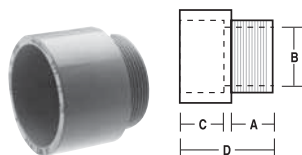

Size (in)	Part Number	Product Code	A (in)	B (in)	C (in)	D (in)
1/2	TA10	077021	0.700	0.591	0.750	1.550
3/4	TA15	077022	0.675	0.790	1.000	1.750
1	TA20	077023	0.625	1.000	1.115	1.860
1-1/4	TA25	077024	0.640	1.311	1.300	2.125
1-1/2	TA30	077025	0.725	1.530	1.425	2.250
2	TA35	077026	0.800	1.970	1.150	2.100
2-1/2	TA40	077027	0.800	2.346	1.900	2.930
3	TA45	077028	0.815	2.915	2.000	3.055
3-1/2	TA50	077029	1.000	3.385	1.715	3.055
4	TA55	077030	0.815	3.850	1.990	3.215
5	TA60	077031	1.725	5.015	2.000	5.985
6	TA65	077032	1.875	6.025	2.130	6.500

Note: 1/2" to 1-1/4" TA – tapered thread.
1-1/2" to 6" TA – non-tapered thread.

Female Adapters

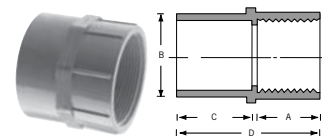

Size (in)	Part Number	Product Code	A (in)	B (in)	C (in)	D (in)
1/2	FA10	076544	0.620	1.080	0.800	1.725
1/2	FA10	077041	0.620	1.080	0.800	1.725
3/4	FA15	077042	0.820	1.300	0.800	1.900
1	FA20	077043	1.065	1.590	1.000	2.300
1-1/4	FA25	077044	1.395	2.000	1.015	2.425
1-1/2	FA30	077045	1.575	2.230	1.050	2.440
2	FA35	077046	2.050	2.720	1.075	2.550
2-1/2	FA40	077047	1.020	3.250	1.500	2.700
3	FA45	077048	3.090	4.000	1.630	4.100
3-1/2	FA50	077049	3.540	4.500	1.800	3.895
4	FA55	077050	4.025	5.000	1.755	4.210
5	FA60	077051	5.035	6.120	2.065	5.240
6	FA65	077052	6.045	7.370	2.065	5.235

Note: All female adapters have NPT-tapered threads.

5° Couplings

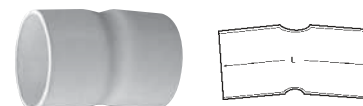

Size (in)	Part Number	Product Code	L (in)
2	5EC35	077100	4.0
2-1/2	5EC40	077101	5.5
3	5EC45	077103	6.0
3-1/2	5EC50	077102	7.0
4	5EC55	077104	7.0
5	5EC60	077105	7.5
6	5EC65	077106	11.0

Threaded Reducer Bushings



Size (in)	Part Number	Product Code
3/4 x 1/2	1825	077314
1 x 1/2	1826	077315
1 x 3/4	1827	077316



Reducer Bushings



Size (in)	Part Number	Product Code
3/4 x 1/2	1805	077300
1 x 1/2	1805-1	077301
1 x 3/4	1806	077302
1-1/4 x 3/4	1807-1	077303
1-1/4 x 1	1807	077304
1-1/2 x 1	1808-1	077305
1-1/2 x 1-1/4	1808	077306
2 x 1	1809-1	077313
2 x 1-1/4	1809	077307
2 x 1-1/2	1810	077308
2-1/2 x 2	1811	077309
3 x 2	1812-1	077310
3 x 2-1/2	1812	077311
4 x 2	1813-1	077319
4 x 3	1813	077312
4 x 3-1/2	1814	077317

*Additional sizes of reducer bushings are available upon request.

End Caps



Size (in)	Part Number	Product Code
1/2	CAP10	077421
3/4	CAP15	077422
1	CAP20	077423
1-1/4	CAP25	077424
1-1/2	CAP30	077425
2	CAP35	077426
2-1/2	CAP40	077427
3	CAP45	077428
3-1/2	CAP50	077429
4	CAP55	077430
5	CAP60	077431
6	CAP65	077432
8	CAP80	077657

"O" Ring Expansion Joints

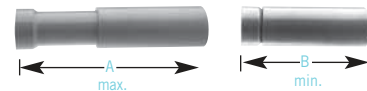

Size (in)	Part Number	Product Code	A (in) max.	B (in) min.
1/2	EJ10	077381	12.00	8.00
3/4	EJ15	077382	12.00	8.00
1	EJ20	077383	12.50	8.50
1-1/4	EJ25	077384	13.00	9.00
1-1/2	EJ30	077385	13.00	9.00
2	EJ35	077386	13.25	9.25
2-1/2	EJ40*	077387	22.25	14.25
3	EJ45	077388	22.25	14.25
3-1/2	EJ50	077389	22.25	14.25
4	EJ55	077390	22.25	14.25
5	EJ60	077391	22.25	14.25
6	EJ65	077392	22.25	14.25

* is a 3" EJ45 with reducer bushings

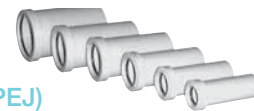

One Piece Expansion Joints (OPEJ)

Size (in)	Part Number	Product Code	A dia. (in)	2 Length	3 Length	Overall Length
1/2	OPEJ10	077018	1.102	0.660	2.465	3.25
3/4	OPEJ15	077019	1.314	0.729	2.646	3.50
1	OPEJ20	077053	1.610	0.885	2.725	3.75
1-1/4	OPEJ25	077054	1.987	0.950	2.895	4.00
1-1/2	OPEJ30	077061	2.208	1.075	3.030	4.25
2	OPEJ35	077063	2.701	1.140	3.206	4.50

Expansion and Deflection Fitting Assemblies



Size (in)	Part Number	Description	Product Code
2*	SE-J-35	Complete Assembly	077889
3*	SE-J-45	Complete Assembly	077890
4*	SE-J-55	Complete Assembly	077891

*Not CSA Certified



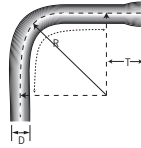

Utility 90° Elbows c/w Solvent Bell End (Bell End x Plain End)

Size (in)	Part Number	Product Code	D (in)	T (in)	R (in)
2	NSL 2-24	069257	2.375	41.20	24
2	NSL 2-36	069260	2.375	31.70	36
3	NSL 3-24	069265	3.500	41.20	24
3	NSL 3-36	069261	3.500	31.70	36
4	NSL 4-36	069267	4.500	31.70	36
4	NSL 4-48	069266	4.500	22.25	48
5	NSL 5-36	069263	5.563	31.70	36
6	NSL 6-36	069264	6.625	31.70	36

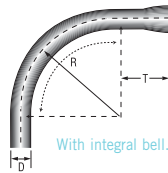

90° Elbows c/w Solvent Bell End (Bell End x Plain End)

Size (in)	Part Number	Product Code	D (in)	T (in)	R (in)
1/2	EE1090	069081	0.840	1.500	4.00
3/4	EE1590	069082	1.050	1.500	4.50
1	EE2090	069083	1.315	1.875	5.75
1-1/4	EE2590	069084	1.660	4.000	7.25
1-1/2	EE3090	069085	1.900	2.000	8.25
2	EE3590	069086	2.375	2.000	9.50
2-1/2	EE4090	069087	2.875	3.000	10.50
3	EE4590	069088	3.500	3.125	13.00
3-1/2*	EE5090	069089	4.000	3.250	15.00
4	EE5590	069090	4.500	3.375	16.00
5	EE6090	069091	5.563	3.625	24.00
6	EE6590	069092	6.625	3.750	30.00
8*	EE7090	069099	8.622	8.300	48.00

* Plain End x Plain End only

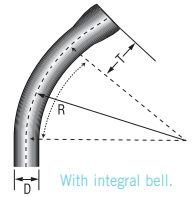

45° Elbows c/w Solvent Bell End (Bell End x Plain End)

Size (in)	Part Number	Product Code	D (in)	T (in)	R (in)
1/2	EE1045	069201	0.840	1.500	4.00
3/4	EE1545	069202	1.050	1.500	4.50
1	EE2045	069203	1.315	1.875	5.75
1-1/4	EE2545	069204	1.660	2.000	7.25
1-1/2	EE3045	069205	1.900	2.000	8.25
2	EE3545	069206	2.375	2.000	9.50
2-1/2	EE4045	069207	2.875	3.000	10.50
3	EE4545	069208	3.500	3.125	13.00
3-1/2*	EE5045	069209	4.000	3.250	15.00
4	EE5545	069210	4.500	3.375	16.00
5	EE6045	069211	5.563	3.625	24.00
6	EE6545	069212	6.625	3.750	30.00
8*	EE7045	069213	8.622	8.300	48.00

* Plain End x Plain End only

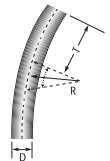

30° Elbows (Plain End x Plain End)

Size (in)	Part Number	Product Code	D (in)	T (in)	R (in)
1/2	EE1030	069241	0.840	1.500	4.00
3/4	EE1530	069242	1.050	1.500	4.50
1	EE2030	069243	1.315	1.875	5.75
1-1/4	EE2530	069244	1.660	2.000	7.25
1-1/2	EE3030	069245	1.900	2.000	8.25
2	EE3530	069246	2.375	2.000	9.50
2-1/2	EE4030	069247	2.750	3.000	10.50
3	EE4530	069248	3.500	3.125	13.00
3-1/2	EE5030	069249	4.000	3.250	15.00
4	EE5530	069250	4.500	3.375	16.00
5	EE6030	069251	5.563	3.625	24.00
6	EE6530	069252	6.625	3.750	30.00
8	EE7030	069254	8.622	8.300	48.00



90° Elbows Extended bend (Bell End x Plain End)

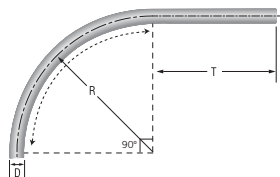

Size (in)	Part Number	Product Code	D (in)	T (in)	T2 (in)	R (in)
1-1/4	EE2590E	069096	1.66	10.24	4.53	6.73
1-1/2	EE3090E	069097	1.90	12.80	2.56	8.25
2	EE3590E	069098	2.38	11.02	2.74	13.00

Pipe Straps PVC, 2 Hole



Size (in)	Part Number	Product Code
1/2	PS10	077811
3/4	PS15	077812
1	PS20	077813
1-1/4	PS25	077814
1-1/2	PS30	077815
2	PS35	077816

Polyethylene (PE), 2 Hole



Size (in)	Part Number	Product Code
2-1/2	PS40	077262
3	PS45	077263
4	PS55	077264

PVC Coated Steel, 2 Hole



Size (in)	Part Number	Product Code
2	CS35	077818
2-1/2	CS40	077819
3	CS45	077820
3-1/2	CS50	077821
4	CS55	077822
5	CS60	077824
6	CS65	077823

PVC Coated Steel, 1 Hole



Size (in)	Part Number	Product Code
1/2	CS10-1	077831
3/4	CS15-1	077832
1	CS20-1	077833
1-1/4	CS25-1	077834
1-1/2	CS30-1	077835
2	CS35-1	077836
3	CS45-1	077838
3-1/2	CS50-1	077839
4	CS55-1	077840

Conduit Clamps & Spacers



Size (in)	Part Number	Product Code	X (in)	Y (in)	Z (in)
1/2	CCS10	077794	1.191	2.414	1.824
3/4	CCS15	077796	1.195	2.660	2.106
1	CCS20	077797	1.215	2.962	2.443
1-1/4	CCS25	077798	1.182	3.300	2.855
1-1/2	CCS30	077799	1.193	3.600	3.170
2	CCS35	077800	1.195	4.135	3.785
Strut Base	CCS-B	077343	-	-	-

* CCS-B are sold individually, two pieces are required to create one base unit.

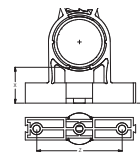

Access Fittings* Type LB

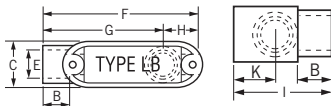

Size (in)	Part Number	Product Code
1/2	SLB10S	077541
3/4	SLB20S	077542
1	SLB30S	077543
1-1/4	SLB40S	077544
1-1/2	SLB50S	077545
2	SLB60S	077546
2-1/2	SLB70S	077547
3	SLB80S	077548
3-1/2	SLB90S	077549
4	SLB100S	077550

Access Fittings* Type LR

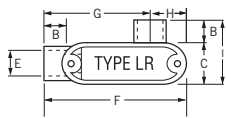

Size (in)	Part Number	Product Code
1/2	SLR10S	077481
3/4	SLR20S	077482
1	SLR30S	077483
1-1/4	SLR40S	077484
1-1/2	SLR50S	077485
2	SLR60S	077486
2-1/2	SLR70S	077480
3	SLR80S	077488
3-1/2	SLR90S	077487
4	SLR100S	077489

Access Fittings* Type LL

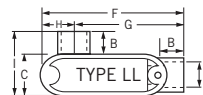

Size (in)	Part Number	Product Code
1/2	SLL10S	077521
3/4	SLL20S	077522
1	SLL30S	077523
1-1/4	SLL40S	077524
1-1/2	SLL50S	077525
2	SLL60S	077526
2-1/2	SLL70S	077527
3	SLL80S	077528
3-1/2	SLL90S	077530
4	SLL100S	077529

Access Fittings* Type C

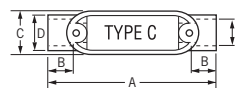

Size (in)	Part Number	Product Code
1/2	SC10S	077501
3/4	SC20S	077502
1	SC30S	077503
1-1/4	SC40S	077504
1-1/2	SC50S	077505
2	SC60S	077506
2-1/2	SC70S	077507
3	SC80S	077508
3-1/2	SC90S	077510
4	SC100S	077509

* All access fittings are CSA and UL listed for wet locations. Supplied with threaded brass inserts, combination brass head screws and PVC gasketing.

* Stainless steel screws are available upon request.

**Not UL Listed.



Access Fittings* Type T

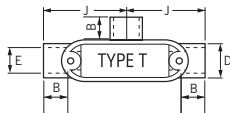

Size (in)	Part Number	Product Code
1/2	ST10S	077461
3/4	ST20S	077462
1	ST30S	077463
1-1/4	ST40S	077464
1-1/2	ST50S	077465
2	ST60S	077466
2-1/2	ST70S	077467
3	ST80S	077468
3-1/2	ST90S	077571
4	ST100S	077572

Access Fittings* Type E

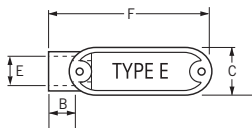

Size (in)	Part Number	Product Code
1/2	SE10S	077561
3/4	SE20S	077562
1	SE30S	077563
1-1/4	SE40S	077564
1-1/2	SE50S	077565
2	SE60S	077566
2-1/2	SE70S	077567
3	SE80S	077568
3-1/2	SE90S	077569
4	SE100S	077570

* All access fittings are CSA and UL listed for wet locations. Supplied with threaded brass inserts, combination brass head screws and PVC gasketing.

* Stainless steel screws are available upon request.

**Not UL Listed.

Access Fittings* Type TB**

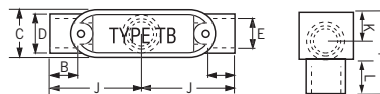

Size (in)	Part Number	Product Code
1/2	STB10S	077451
3/4	STB20S	077452
1	STB30S	077453
1-1/4	STB40S	077454
1-1/2	STB50S	077455
2	STB60S	077456

Access Fitting Dimensions*

Size (in)	A (in)	B (in)	C (in)	D (in)	E (in)	F (in)
1/2	5.606	0.639	1.268	1.100	0.840	4.337
3/4	5.606	0.810	1.536	1.325	1.050	5.395
1	6.500	0.910	1.700	1.600	1.335	6.250
1-1/4	7.900	1.050	2.300	2.250	1.660	7.625
1-1/2	8.500	1.125	2.675	2.250	1.900	8.250
2	10.875	1.160	3.188	2.820	2.375	10.531
2-1/2	14.600	1.750	4.500	3.950	2.870	13.630
3	14.600	1.900	4.500	3.950	3.510	13.630
3-1/2	17.040	2.125	5.536	5.000	4.000	16.000
4	17.040	2.125	5.536	5.000	4.530	16.000

Size (in)	G (in)	H (in)	I (in)	J (in)	K (in)	L (in)
1/2	4.095	1.297	2.487	2.280	1.005	0.750
3/4	4.095	1.297	2.487	2.803	1.005	0.810
1	4.750	1.500	2.075	3.250	1.125	1.115
1-1/4	5.750	1.750	3.575	3.950	1.562	1.300
1-1/2	6.500	1.750	3.938	4.250	1.656	1.425
2	8.156	2.344	4.535	5.438	1.968	1.160
2-1/2	9.825	3.805	6.240	7.300	2.610	-
3	10.897	2.733	6.240	7.300	2.610	-
3-1/2	11.465	4.535	7.500	8.535	2.975	-
4	11.465	4.535	7.500	8.535	2.975	-

* All access fittings are CSA and UL listed for wet locations. Supplied with threaded brass inserts, combination brass head screws and PVC gasketing.

* Stainless steel screws are available upon request.

**Not UL Listed.





End Bells

Size (in)	Part Number	Product Code
1/2	EB-10	077406
3/4	EB-15	077085
1	EB-20	077323
1-1/4	EB-25	077324
1-1/2	EB-30	077325
2	EB-35	077326
2-1/2	EB-40	077327
3	EB-45	077328
3-1/2	EB-50	077329
4	EB-55	077330
5	EB-60	077331
6	EB-65	077332
8	EB-80	077652



Service Entrance Fittings

Size (in)	Part Number	Product Code
1/2	EF10	077281
3/4	EF15	077282
1	EF20	077283
1-1/4	EF25	077284
1-1/2	EF30	077285
2	EF35	077286
2-1/2	EF40	077287
3	EF45	077288
3-1/2	EF50	077289
4	EF55	077290



Meter Offsets

Size (in)	Part Number	Product Code
1-1/4	M025	077941
2	M035	077942

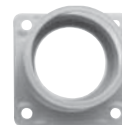

Meter Hubs

Size (in)	Part Number	Product Code
1-1/4	MHU25	077961
1-1/2	MHU30	077963
2	MHU35	077965
2-1/2	MHU40	077967
3	MHU45	077968

Long Meter Offsets (Fabricated)



Size (in)	Part Number	Product Code
1-1/4	LM025	069641
1-1/2	LM030	069645
2	LM035	069646

“Two in One” Pull Elbow

The “two in one” access pull elbow reduces inventory costs & increases installation flexibility (3/4" hub fitting supplied with 3/4" x 1/2" reducers). The pull elbow is approved for wet location use and is manufactured from high impact, nonconducting and noncorroding PVC.



Size (in)	Part Number	Product Code
1/2 or 3/4	PE15/10	077491

Nonmetallic Threaded Strain Relief Connector c/w “O” Ring, Locknut & 6 Grommets



Size (in)	Part Number	Product Code
1/2	TSRC10	077754
3/4	TSRC15	077756









Strain Relief Connectors c/w 6 Grommets



Size (in)	Part Number	Product Code
3/4	SRC15	077985

Strain Relief Connectors Grommet Dimensions

Grommet	From	To	Grommet	From	To
	W = .195"	W = .285"		Ø = .290"	Ø = .385"
	L = .450"	L = .530"			
	W = .220"	W = .291"		Ø = .405"	Ø = .500"
	L = .516"	L = .565"			
	Ø = .240"	Ø = .300"		Ø = .525"	Ø = .625"

Note: All grommets are supplied with TSRC10, TSRC15 and SRC15.

F Series - Single Gang Plates



Description	Part Number	Product Code
Duplex Receptacle	DRC15/10	077617
Toggle Switch	TSC15/10	077616
Single Receptacle	20RC15/10	077618
Single Receptacle	20-3RC15/10	077619
Single Receptacle	30RC15/10	077620
Blank c/w Gasket	BRC15/10	077611
PVC Gasket	GASK15/10	077621

F Series - Double Gang Plates – OLD Style



Description	Part Number	Product Code
Blank Cover c/w Gasket	BRC20-2	077614
Double Switch	TSC20-2	077738
Double Duplex Receptacle	DRC20-2	077740
Combo Switch Duplex Rec.	TSDC20-2	077739
PVC Gasket	GASK20-2	077743

F Series - Universal Double Gang Plates – NEW Style *(only fits new style double gang boxes)*

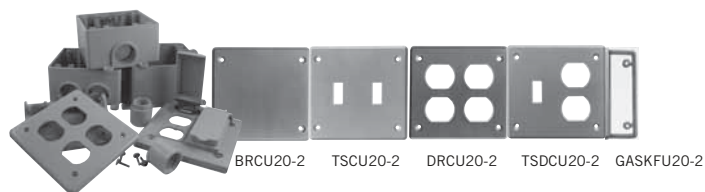

Description	Part Number	Product Code
Blank Cover c/w Gasket	BRCU20-2	077359
Double Switch	TSCU20-2	077373
Double Duplex Receptacle	DRCU20-2	077362
Combo Switch Duplex Receptacle	TSDCU20-2	077374
PVC Gasket	GASKFU20-2	172650

F Series - Triple Gang Plates



Description	Part Number	Product Code
Triple Receptacle	DRC20-3	077747
Combo Switch Receptacle	DSDR20-3	077745
Triple Switch	TSC20-3	077744
Combo Switch Receptacle	TSDC20-3	077746
Blank Cover c/w Gasket	BRC20-3	077748
PVC Gasket	GASK20-3	077749



Weatherproof Covers - Single Gang

	Description	(in)	Part Number	Product Code
 VPT15/10	Plunger-style Switch Cover		VPT15/10	077630
 VSC15/10	Toggle Switch Cover		VSC15/10	077612
 WTG15/10	Grey Toggle Switch Cover		WTG15/10	077606
 WDR15/10 RWDR15/10	Grey Duplex Receptacle		WDR15/10	077993
 RWDR15/10	White Duplex Receptacle		RWDR15/10	077786
 WGF15/10 RWGF15/10	Grey Ground Fault Receptacle		WGF15/10	077785
 RWGF15/10	White Ground Fault Receptacle		RWGF15/10	077787
 WTL15	Single Receptacle Device 15 AMP	1.375	WTL15	077992
 WTL20	Single Receptacle Device 20 AMP	1.625	WTL20	077994
 WTL30	Single Receptacle Device 30 AMP	1.722	WTL30	077991
 WTL50	Single Receptacle Device 50 AMP	2.187	WTL50	077951
 WDRE15/10	Grey Double Door Duplex Receptacle		WDRE15/10	077087
 RWDR15/10	White Double Door Duplex Receptacle		RWDR15/10	077408
WDRE15/10 RWDR15/10	Gasket for W Series Cover (except WDRE & RWDR)		GASKW	077755
	Gasket for WDRE & RWDR Covers		GASKDD	072225

Note: Weatherproof covers, with lids closed, are CSA and UL Listed for wet locations.

Weatherproof Covers - Double Gang – OLD Style

Description	Part Number	Product Code
Toggle Switch Cover	VSC20-2	077741
Combination Switch & GFI Receptacle	VSRC20-2	077742
Combination Switch & Duplex Receptacle	VSDR20-2	077752
Combination Switch & Single Receptacle Cover	VSR20-2	077753
Double Door GFCI Cover	VSGG20-2	077096
Double Door Duplex Cover	VSDD20-2	077097
Gasket for 2-Gang 'F' Boxes (except VSGG20-2 & VSDD20-2)	GASK20-2	077743
Gasket for VSGG20-2 & VSDD20-2 Double Gangs	GASKV20-2	072227

Weatherproof Covers - Double Gang – NEW Style
(only fits new style gang boxes)

Description	Part Number	Product Code
Toggle Switch Cover	VSCU20-2	077376
Combination Switch Cover & GFI Receptacle	VSRCU20-2	077357
Combination Switch Cover & Duplex Receptacle	VSDRU20-2	077356
Gasket	GASKFU20-2	172650

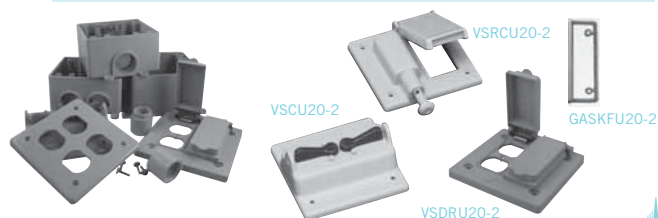

F Series Single Gang Boxes

Outside Dimensions:

Height, 4⁹/₁₆" – Width, 2¹³/₁₆" – Depth 2", Cubic Inches = 25.67

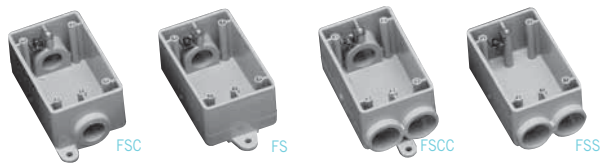

Size (in)	Part Number	Product Code
1/2	FSC10	077607
3/4	FSC15	077608
1/2	FS10	077601
3/4	FS15	077602
1/2	FSCC10	077622
3/4	FSCC15	077623
1/2	FSS10	077604
3/4	FSS15	077605

Note: 10 = 1/2" Hub, 15 = 3/4" Hub

FD Series Single Gang Deep Boxes

Outside Dimensions:

Height, 4⁹/₁₆" – Width, 2¹³/₁₆" – Depth 2³/₄", Cubic Inches = 35.30

With the exception of the FD Blank Box, Scepter FD Series Single Gang Deep Boxes are molded with 1" conduit hubs and supplied with reducer bushings. The conduit hub(s) are field modified as 1/2", 3/4" or 1" to accommodate job-site requirements. The appropriate quantity of 1" x 3/4" and 3/4" x 1/2" reducers to create the desired hub size are packaged with each FD Series Single Gang Deep Box.

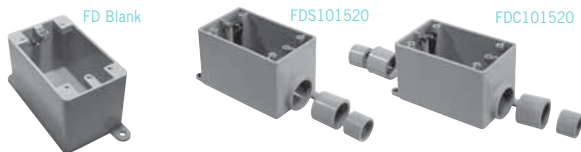

Size (in)	Part Number	Product Code
1/2, 3/4, 1	FDC101520	077291
1/2, 3/4, 1	FDS101520	077299
BLANK	FD BLANK	077603
347 VOLT	FD347	077610

F-Series Universal Double Gang Boxes – NEW Style

FSU-2 cu.in. = 39.5, FSCU-2 & FSSU-2 cu.in. = 37.0, FSCCU-2 cu.in.= 36.0

Hub Size (in)	Part Number	Product Code	OD (inches)			
			H	W	D	
1/2, 3/4, 1	FSU-2-101520	077364	4.5	4.75	2.5	
1/2, 3/4, 1	FSCU-2-101520	077368	4.5	4.75	2.5	
1/2, 3/4, 1	FSSU-2-101520	077372	4.5	4.75	2.5	
1/2, 3/4, 1	FSCCU-2-101520	077369	4.5	4.75	2.5	
	Blank	FDU-2	077649	4.75	4.75	3.0

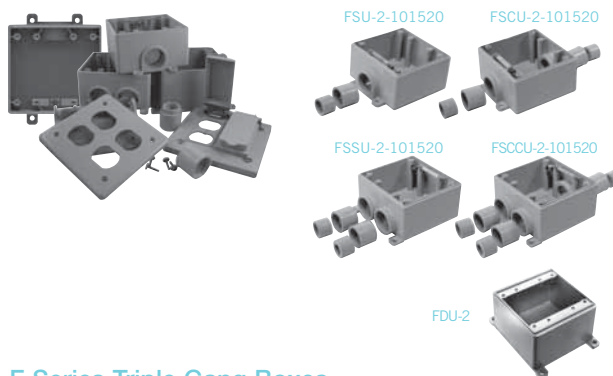

F Series Triple Gang Boxes

Hub Size (in)	Part Number	Product Code	OD (inches)			
			H	W	D	
1/2, 3/4, 1	FS-3-101520	077337	4.5	6.6	2.5	
1/2, 3/4, 1	FSC-3-101520	077438	4.5	6.6	2.5	
	Blank	FD-3	077737	4.5	6.6	3.0

Note: All F series boxes are supplied with integral mounting feet, threaded brass inserts and grounding clips.

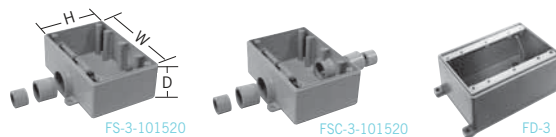

Scepter JBox

Introducing the NEW Scepter® JBox™, the Next Generation Junction Box. The original junction box is completely redesigned and new features have been added to make this the easiest box to use. The patent pending integral gasket, non-metallic fasteners, molded mounting feet, embossed grid-lines and flat cover features have been engineered to provide a contractor-friendly junction box.



FEATURES & BENEFITS

Hand-Close Fasteners

- Close by hand – tool assist to open
- 100% non-metallic – corrosion resistant material
- No loose hardware for easy installation



Smooth Flat Cover

- No ribs – offers a flat, smooth surface for mounting of devices or labels

Integrated Gasket

- Injection molded gasket permanently fixed to the cover – no installation required
- Proprietary material provides NEMA 1, 2, 3R, 4, 4X, 6, 6P, 12, 13

Molded Mounting Feet

- Molded – no loose parts to assemble
- Located on corners out of the way of conduit connections
- Flush with the back of the box for close surface mounting
- Integrated design of mounting feet offers improved strength

Built-in Gridlines

- Easy reference for drilling knockouts
- Makes conduit alignment a snap

Size inches	Part Number	Product Code	L1	W1	L2	W2	H	M1	M2	G1	G2	J1	J2	D	K
4x4x2	JBX442	277000	4.97	3.93	3.48	3.48	2.90	4.48	3.44	2.41	1.09	1.72	1.09	0.51	0.24
4x4x4	JBX444	277001	4.90	3.86	3.48	3.48	4.89	4.41	3.37	2.22	2.97	1.59	2.97	0.59	0.24
5x5x2	JBX552	277002	5.97	4.93	4.55	4.55	2.90	5.48	4.44	3.41	1.09	2.69	1.09	0.51	0.24
6x3x4	JBX634	277003	3.90	5.86	2.48	5.48	4.89	3.41	5.37	1.22	2.72	3.42	2.72	0.59	0.28
6x6x4	JBX664	277004	7.58	7.58	5.86	7.20	4.90	6.90	6.90	4.47	2.47	4.47	2.47	0.59	0.28
6x6x6	JBX666	277005	7.51	7.51	5.79	7.13	6.90	6.83	6.83	4.22	4.47	4.22	4.47	0.72	0.28

Size inches	Part Number	Product Code	L1	W1	L2	W2	H	M1	M2	G1	G2	N1	N2	P1	P2	D	K
8x8x4	JBX884	277006	9.58	9.58	7.86	9.20	4.90	8.90	8.90	6.47	1.97	8.25	6.26	3.94	3.13	0.59	0.28
8x8x7	JBX887	277007	9.47	9.47	7.76	9.10	7.90	8.90	8.90	6.22	4.65	8.25	6.26	3.94	3.13	0.75	0.28
12x12x4	JBX12124	277008	13.58	12.24	11.74	11.74	4.90	12.90	11.56	9.28	2.03	10.26	10.25	3.94	3.13	0.56	0.28
12x12x6	JBX12126	277009	13.58	12.24	11.74	11.74	6.90	12.90	11.56	9.03	3.78	10.26	10.25	3.94	3.13	0.67	0.28
12x12x8	JBX12128	277010	13.58	12.24	11.74	11.74	8.90	12.90	11.56	8.81	5.64	10.26	10.25	3.94	3.13	0.76	0.28

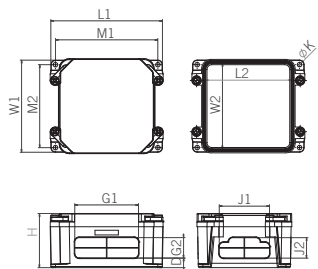

JBX442 - JBX666

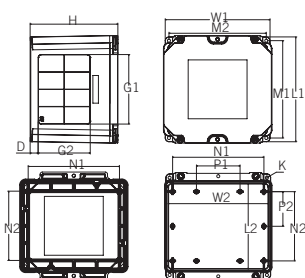

JBX884 - JBX887

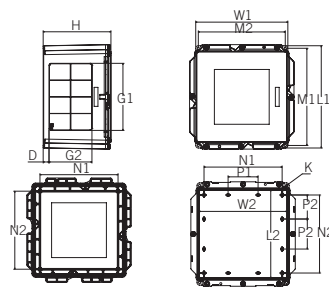

JBX12124 - JBX12128



Scepter JBox with Hinged Cover

The NEW Scepter JBox Hinged Cover opens more than 180° for complete and easy access to control devices and instruments and is designed to work with your existing PVC conduit runs. The Scepter JBox Hinged Cover is NEMA 3R and 4X rated, ideally suited for indoor and outdoor use and in wash-down environments. It is 100% non-metallic and includes all the features that users have come to appreciate in the Scepter JBox.

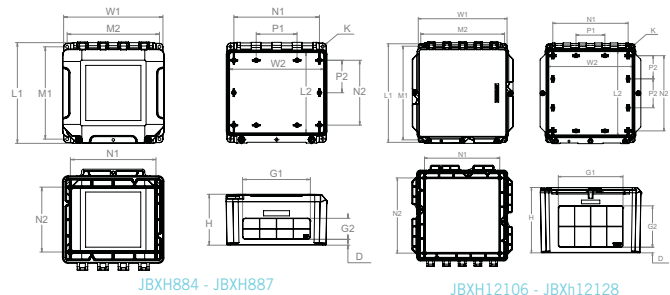

JBXH884 - JBXH887

JBXH12106 - JBXH12128

Size inches	Part Number	Product Code	L1	W1	L2	W2	H	M1	M2	G1	G2	N1	N2	P1	P2	D	K
8x8x4	JBXH884	277100	9.58	9.58	7.86	9.2	4.9	8.9	8.9	6.47	1.97	8.25	6.26	3.94	3.13	0.59	0.28
8x8x7	JBXH887	277101	9.47	9.47	7.86	9.2	7.9	8.9	8.9	6.22	4.65	8.25	6.26	3.94	3.13	0.75	0.28
12x10x6	JBXH12106	277102	11.51	12.17	9.67	11.67	6.9	10.8	11.49	8.03	3.78	10.25	8.26	3.94	2.16	0.67	0.28
12x12x4	JBXH12124	277103	13.58	12.24	11.74	11.74	4.9	12.9	11.56	9.28	2.03	10.26	10.25	3.94	3.13	0.56	0.28
12x12x6	JBXH12126	277104	13.58	12.24	11.74	11.74	6.9	12.9	11.56	9.03	3.78	10.26	10.25	3.94	3.13	0.67	0.28

Scepter JBox Pole Mounting Kit

- One kit fits 4" to 12" new Scepter JBoxes (PMK4-12)
- Supplied as a complete kit (sold separately)
- Works with wood, concrete, steel and composite poles
- Installs on round, square & octagonal poles up to 15"



Description	Part Number	Product Code
Pole Mount Kit	PMK4-12	077940

Scepter JBox Back Panels

- Made of 14 gauge carbon steel
- White epoxy powder-coated finish
- Easy to cut and drill to mount devices

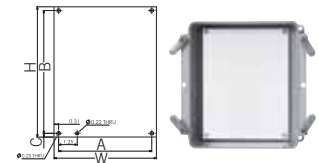

Size inches	Part Number	Product Code	W	H	A	B	C
6x6	BP66CSW	077864	4.88	6.75	4.26	6.25	0.25
8x8	BP88CSW	077861	6.88	8.75	6.26	8.25	0.25
12x10	BP1210CSW	077862	8.88	10.75	8.26	10.25	0.25
12x12	BP1212CSW	077865	10.88	10.75	10.26	10.25	0.25



NEW
HINGED COVER

The RIGHT BOX for the RIGHT Environment

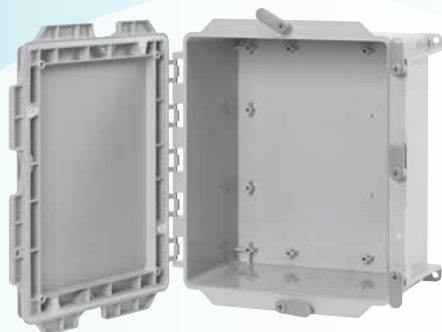

Tested to perform in demanding industrial environments, the new Scepter Hinged Cover JBox junction box has added features to make this the easiest box to use – no matter the situation.

FEATURE & BENEFITS

- Hinged Cover
- Fastener System
- Integrated Gasket
- Flat Cover Conditions
- Flat Cover
- Grid Lines
- Molded Panel Mounts

Visit www.ipexna.com

Octagonal Boxes*

Octagonal Boxes are shipped complete with cover, gasket, 4 reducing bushings (3/4" x 1/2") and 3 knock-out plugs to be installed from inside box to seal off unused entry hubs.

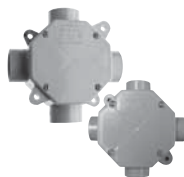

Size (in)	Part Number	Hub Size (in)	Product Code
4 x 1-1/2	OB15/10	1/2 – 3/4	077983
4 x 2-1/8	OB20	1	077984

Octagonal Box Extension Rings

Size (in)	Part Number	Product Code
4 x 1 deep	XR20	077989*
4 x 2 deep	XR35	077990*



Octagonal Boxes are not designed for supporting luminaires.

Flanged Box with Fibre-Reinforced Safety Tread Cover

Scepter's Flanged 'H' Series Junction Boxes provide H10 Highway Loading. The fiber-reinforced safety tread cover secures using recessed Hex Key fastening hardware offering a simple installation while reducing the opportunity for tampering. These boxes are not CSA Certified and are not returnable.

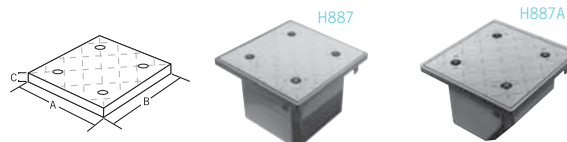

Size (in)	Part Number	Box ID (in)			Lid Dimensions (in)		
		L	W	D	A	B	C
H664	077685	6	6	4-1/4	9.0	9.0	0.60
H666	077686	6	6	6-1/4	9.0	9.0	0.60
H884	077687	8	8	4-1/4	11.5	11.5	0.75
H886	077688	8	8	6-1/4	11.5	11.5	0.75
H887	077689	8	8	7-1/4	11.5	11.5	0.75
H887-A	077692	8	8	7-1/4	11.5	11.5	0.75

Fabricated Boxes

Unflanged PVC fabricated boxes of any size may be made to customers' specifications and come complete with lids, gaskets and screws. These boxes are not CSA Certified and are not returnable.

Junction Box Adapters

Size (in)	Part Number	Product Code
1/2	JBA10	077721
3/4	JBA15	077722
1	JBA20	077723
1-1/4	JBA25	077724
1-1/2	JBA30	077725
2	JBA35	077726
2-1/2	JBA40	077727
3	JBA45	077728
3-1/2	JBA50	077729
4	JBA55	077730

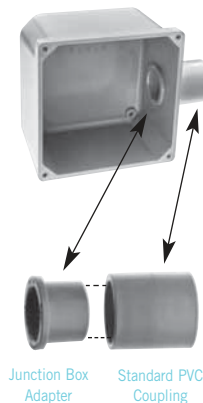

Junction Box Adapter Standard PVC Coupling



Nonmetallic Floor Box, Cover & Metal Cover Adapter

Installation is quick and simple with our nonmetallic floor box and covers, saving both time and money over similar metallic assemblies.

Scepter's floor box and duplex receptacle covers are constructed from high impact, noncorroding and nonconducting PVC.

The flush-mount covers are available in custom colours and are shipped with a leveling ring complete with a grounding clip. Metal cover adapter kits are also available, allowing you to adapt to metal floor plates. Our 6" deep floor box allows flexibility for various concrete floor pours, while the 4 3/4" width offers easy access and ample wire room. Scepter's FB box is molded with 2 - 1" and 2 - 3/4" hub openings.

All boxes are shipped complete with reducer plugs for added versatility.

One Kit, Four Heights, One Low Cost!

This simple yet innovative **Round Floor Box Stand** is equipped with several height brackets which accommodate the different rebar and post-tension cable heights and slab depths found from jobsite to job-site. When installed together, the Floor Box and Stand can be used in 5-1/2" to 10" slab depths.

Sold as a Kit, IPEX offers the Round Floor Box and Stand conveniently packaged together as one complete product offering.



FEATURE & BENEFITS

- Four Adjustable Heights
- Raises Entrance Hubs to Rebar
- Minimizes Footprint on Concrete Form
- Withstands Tough Job Site Conditions
- Easy to Install
- Cost Effective

For more information, visit our website www.ipexna.com

Description	Part Number	Product Code
-------------	-------------	--------------

Floor Box Base

(Includes disposable protective cap & reducer plugs)

076954 FB



FB

Floor Box Base c/w Leveling Ring Adapter

(includes disposable protective cap, reducer plugs & leveling ring adapter)

077068 FBKIT



FBKIT

Floor Box Stand Kit (includes FB Box)

(is equipped with several height brackets which accommodate the different rebar and post-tension cable heights and slab depths found from job-site to job-site.)

077700 FBS-KIT



AFMC

Metal Cover Adapter Kit

(includes leveling ring, metal cover adapter & 2 gaskets)

076953 AFMC



LRA-U

Universal Leveling Ring Adapter

076606 LRA-U

Floor Box Duplex Receptacle Cover (Nonmetallic)

(includes flush mount cover, blank cover & gasket)

Brown	076943	FBDRCB
Gold	076942	FBDRCG
Grey	076941	FBDRCGr
Light Almond	076940	FBDRCA



FBUDK

Tri-Service Universal Divider Kit

(includes upper & lower dividers, riser tube & 2 grommets)

077948 FBUDK



FBUDK

Y Connector (3/4")

077499 FBYC



FBYC



Brass and Nickel Cover Plates

These cover plates help to protect enclosed power data and communications wiring from daily environmental floor conditions such as mopping (UL scrub water tested) and foot traffic (UL approved for cover loading).

The covers feature a light lacquer finish for extra strength and durability in high traffic areas and include a rubber gasket and aluminum backing plate to create a water-tight seal. The flush mount cover plates should be installed to the floor box using the LRA-U.



new

Nickel Cover Plates

Description	Part Number	Product Code
Duplex Receptacle Cover with Dual Flip Lid	DFL-2-N	178279
Duplex Receptacle Cover with Individual Screw Plug Openings	SSC-N	178278
Combination 2" x 1/2" Single Screw Plug Opening	DSC-N	178280



DFL-2-N



SSC-N



DSC-N

Brass Cover Plates

Description	Part Number	Product Code
Duplex Receptacle Cover with Dual Flip Lid	DFL-2	178096
Duplex Receptacle Cover with Individual Screw Plug Openings	SSC	178093
Combination 2" x 1/2" Single Screw Plug Opening	DSC	178091
Combination 2" x 1/2" Single Screw Plug and 1/2" Datacomm Opening	DSC-P/C	178092



DFL-2



SSC



DSC-N

Conduit Cements

IPEX Electrical 100 Conduit Cements are low VOC. Our reduced emission cements have been tested to meet the requirements of SCAQMD Rule 1168, Test Method 316A (South Coast Air Quality Management District).

- Low VOC Solvent Cement is LEED (Leadership in Energy and Environmental Design) compliant.
- PVC is recyclable and can be reground into new product.
- VOC emissions are less than 510 grams per litre for PVC Solvent Cement.

IPEX 100 PVC Conduit Solvent Cement



Size	Part Number	Product Code
125ml	S100PT25	074717
250ml	S100PT5	074713
500ml	S100PT	074714
1L	S100QT	074715
4L	S100GAL	074716

IPEX 100T Primer



Size	Part Number	Product Code
250ml	C100PT5	074306
500ml	C100PT	074307
1L	C100QT	074308

Empty Applican

Size	Part Number	Product Code
500ml (Pint)	APPLICAN	074728

Average # of Joints per Pint or Quart of Cement

Nominal Pipe Size		# of Joints		Nominal Pipe Size		# of Joints	
inches	mm	/Pint	/Quart	inches	mm	/Pint	/Quart
1/2	12	350	700	2-1/2	12	40	80
3/4	19	200	400	3	19	35	70
1	25	150	300	3-1/2	25	30	60
1-1/4	32	110	220	4	32	24	48
1-1/2	38	80	160	5	38	10	20
2	50	45	90	6	50	8	16



Conduit Repair Kit

EPR Kit for Conduit Repair

EPR Kits from IPEX are the first total repair systems for broken and damaged PVC conduit. They offer fast and easy repairs for damaged conduit caused by actions such as earth excavation, horizontal and core drilling. All sizes are 24 inches in length.



Size (in)	Part Number	Product Code
1-1/4	EPR25	077982
1-1/2	EPR30	077981
2	EPR35	077980
2-1/2	EPR40	077960
3	EPR45	077958
4	EPR55	077957
5	EPR60	077956
6	EPR65	077955

EPR Kit Adapters for Duct Repair

EPR Conduit Repair Kits allow contractors to repair a broken section of DB-II duct while leaving the cables inside. The Adapters are pre-cut allowing each to open around existing cabling and are then solvent cemented onto the outside diameter of the broken duct. Using standard PVC solvent cement, an EPR Kit is then easily assembled and connected to the Adapters, restoring the duct to its original form.

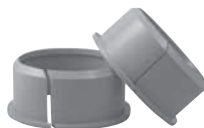

Size (in)	Part Number	Product Code
2	EPRA35	077852
3	EPRA45	077853
4	EPRA55	077854
5	EPRA60	077855
6	EPRA65	077856



SCEPTALIGHT: The Light That Lasts

Sceptalight fixtures from IPEX prove themselves to be all round performers in a variety of indoor and outdoor applications.

Sceptalight fixtures are made from a glass-reinforced thermoplastic polyester resin, which enable them to stand up better to corrosive elements than metal. This thermoplastic design marries an unrivaled balance of strength, stiffness and toughness with all the benefits users appreciate of Scepter rigid PVC conduit and fittings - long life, easy servicing and high impact-resistance.

Sceptalight's thermoplastic construction offers outstanding corrosion and chemical resistance. And its interior and exterior silicone gaskets create a watertight seal, the reason it performs equally well indoors and outside.

Features and Benefits

- Stable Construction
- Watertight seal with weather-resistant silicone gaskets
- Corrosion Resistant
- Durable and Impact Resistant

Mounting Options

CEILING MOUNT



Box with four 3/4" threaded hubs and integral mounting feet.

WALL MOUNT



Box with four 3/4" threaded hubs, 90° wall bracket and integral mounting feet.

PENDANT MOUNT



Pendant cap with 3/4" threaded hub and a locking set screw.



Globe Options

Sceptalight offers a variety of globe options to suit a wide range of applications and environments. Our standard clear glass globes are ideal for general purpose area lighting for either indoor or outdoor use. Polycarbonate globes offer impact resistance in case of accidental contact and the assurance that work areas are not contaminated by broken glass. Coloured globes - available in red, blue, green or amber - can transform the light to an indicator or warning light.



Clear
Polycarbonate



Standard or Heat-treated
Clear Glass



Heat-treated
Red Glass



Heat-treated
Blue Glass



Heat-treated
Green Glass



Heat-treated
Amber Glass

Light Options

Fluorescents

Our compact fluorescent fixtures work four to five times more efficiently per watt than incandescents and provide 10-20 times the lamp life, yet use approximately 75% less energy. In this way, Sceptalight fluorescents lower energy and maintenance costs without sacrificing light levels.

Incandescents

With their low initial cost, Sceptalight incandescent fixtures make the most practical choice to meet the daily needs of commercial, industrial, marine and agricultural applications. Our incandescents are ideal for short burn times as well as flashing and dimming applications.



Wet Locations

C22.2 No. 250
UL 1598
Minimum 60°C supply conductors

Ceiling Mount

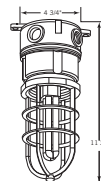

Ceiling Mount

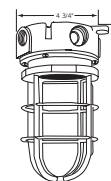

Ceiling Mount

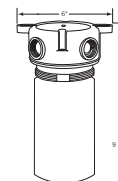

Ceiling Mount
Polycarbonate Globe

Ceiling Mount with Standard Clear Glass Globe		Part Number	Product Code
150W	Incandescent	LVPF150C	077225
150W	Incandescent less guard	LVPF150LG	077237
26W	Compact Fluorescent	LVPL26C	077170
18W	Compact Fluorescent	LVPL18C	077210
13W	Compact Fluorescent	LVPL13C	077122
9W	Compact Fluorescent	LVPL9C	077121
7W	Compact Fluorescent	LVPL7C	077120

Ceiling Mount with Clear Polycarbonate Glass Globe (no guard)		Part Number	Product Code
26W	Compact Fluorescent	LVPL26PCC	077176
18W	Compact Fluorescent	LVPL18PCC	077211
13W	Compact Fluorescent	LVPL13PCC	077165
9W	Compact Fluorescent	LVPL9PCC	077155
7W	Compact Fluorescent	LVPL7PCC	077145





Wet Locations cont'

Pendant Mount

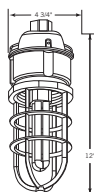

Pendant Mount with Standard Clear Glass Globe		Part Number	Product Code
150W	Incandescent	LPMF150C	077231
26W	Compact Fluorescent	LPPL26C	077184
18W	Compact Fluorescent	LPPL18C	077212
13W	Compact Fluorescent	LPPL13C	077185
9W	Compact Fluorescent	LPPL9C	077183
7W	Compact Fluorescent	LPPL7C	077182
Pendant Mount with Clear Polycarbonate Globe (no guard)		Part Number	Product Code
26W	Compact Fluorescent	LPPL26PCC	077375
18W	Compact Fluorescent	LPPL18PCC	077273
13W	Compact Fluorescent	LPPL13PCC	077365
9W	Compact Fluorescent	LPPL9PCC	077355
7W	Compact Fluorescent	LPPL7PCC	077345

Wall Mount

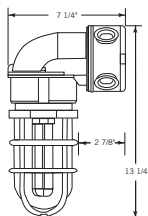

Description	Part Number	Product Code
For wall mount fixtures select and order the appropriate style (wattage and globe) ceiling mount fixture from above and add LWB150 Wall Mount bracket	LWB150	077233



Hazardous Locations

UL 844
Class I, Div 2 Groups A, B, C & D
Class II, Div 2 Groups F & G
Minimum 90°C supply conductors

Ceiling Mount

Ceiling Mount with Heat Resistant Glass Globe	Part Number	Product Code
150W Incandescent clear	LVPF150HRC-HAZ	077414
150W Incandescent red	LVPF150HRR-HAZ	077415
150W Incandescent blue	LVPF150HRB-HAZ	077416
150W Incandescent green	LVPF150HRG-HAZ	077417
150W Incandescent amber	LVPF150HRA-HAZ	077494
26W Compact Fluorescent clear	LVPL26HRC-HAZ	077377
26W Compact Fluorescent red	LVPL26HRR-HAZ	077378
26W Compact Fluorescent blue	LVPL26HRB-HAZ	077379
26W Compact Fluorescent green	LVPL26HRG-HAZ	077399
26W Compact Fluorescent amber	LVPL26HRA-HAZ	077400
18W Compact Fluorescent clear	LVPL18HRC-HAZ	077347
18W Compact Fluorescent red	LVPL18HRR-HAZ	077348
18W Compact Fluorescent blue	LVPL18HRB-HAZ	077349
18W Compact Fluorescent green	LVPL18HRG-HAZ	077353
18W Compact Fluorescent amber	LVPL18HRA-HAZ	077354

Pendant Mount

Pendant Mount with Heat Resistant Glass Globe	Part Number	Product Code
150W Incandescent clear	LPMF150HRC-HAZ	077495
150W Incandescent red	LPMF150HRR-HAZ	077496
26W Compact Fluorescent clear	LPPL26HRC-HAZ	077407
26W Compact Fluorescent red	LPPL26HRR-HAZ	077409
18W Compact Fluorescent clear	LPPL18HRC-HAZ	077500
18W Compact Fluorescent red	LPPL18HRR-HAZ	077498

Wall Mount

Description	Part Number	Product Code
For wall mount fixtures select and order the appropriate style (wattage and globe) ceiling mount fixture from above and add LWB150 Wall Mount bracket	LWB150	077233



Nonmetallic Utility Light Fixture

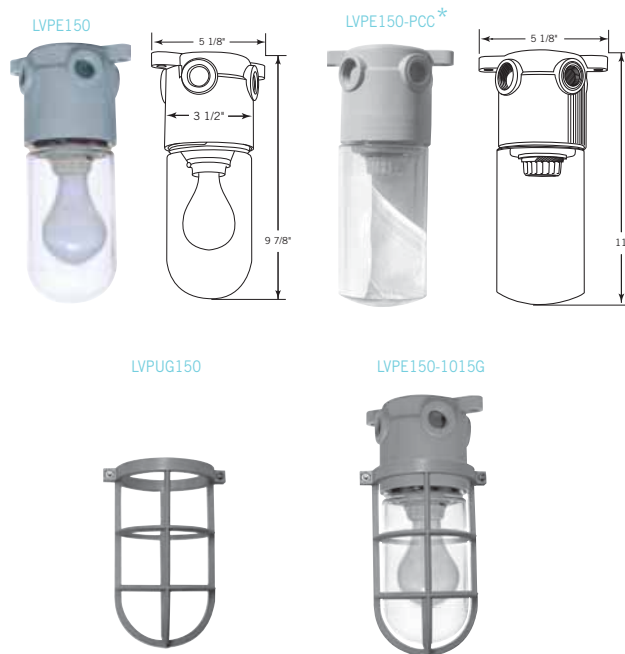

Description	Part Number	Hub Size	Product Code
Fixture c/w Clear Glass Globe	LVPE150-10/15	1/2" - 3/4"	077493
Fixture c/w Clear Polycarbonate Globe	LVPE150-PCC*	1/2" - 3/4"	077181
Fixture c/w Heat Resistant Clear Globe	LVPE150-HRC	1/2" - 3/4"	077578
Fixture c/w Heat Resistant Red Globe	LVPE150-HRR	1/2" - 3/4"	077599
Fixture c/w Heat Resistant Blue Globe	LVPE150-HRB	1/2" - 3/4"	077579
Fixture c/w Heat Resistant Green Globe	LVPE150-HRG	1/2" - 3/4"	077597
Fixture c/w Heat Resistant Amber Globe	LVPE150-HRA	1/2" - 3/4"	077598
Replacement Clear Glass Globe	LGC150		077247
Nonmetallic Clamp-on Guard	LVPUG150		077558
Fixture c/w Clear Glass Globe & Clamp-on guard	LVPE150-1015G	1/2" - 3/4"	077402

* Maximum 60W incandescent lamp with polycarbonate globe

Accessories & Components



Standard Glass Globes

Description	Part Number	Product Code
Clear	LGC150	077247



Heat Resistant Globes

Description	Part Number	Product Code
Clear	LG150T	077909
Red	LCGR150T	077239
Blue	LCGB150T	077910
Green	LCGG150T	077241
Amber	LCGA150T	077242

Polycarbonate Globes (for use with compact fluorescent or maximum 60W incandescent lamp)



Description	Part Number	Product Code
Clear	LPCC18	077911
Red	LPCR18	077912
Blue	LPCB18	077913
Green	LPCG18	077914
Amber	LPCA18	077915

Threaded Junction Boxes



Part Number	Product Code
LFB150C	077250
LFB150T *	077251

*LFB150T complete with 1/2 threaded" hole in center of cover



Accessories & Components con't

Fixture Components (LVPF, LVPL, LPMF, LPPL)

Description	Part Number	Product Code
Ceiling Mount Box	LVPB 150	077243
Pendant Mount Cap	LPC 150	077246
90 Wall Bracket	LWB 150	077233
Socket Base Assembly	LSBA 150	077245
Medium Base Replacement Socket	LSOC 150	077249
Screw-on Guard	LVPG 150	077978

Replacement Lamps

Description	Part Number	Product Code
7 Watt	LD/E 7	072841
9 Watt	LD/E 9	072844
13 Watt	LD/E 13	072847
18 Watt (Quad)	LD/E 18	077947
26 Watt (Quad)	LD/E 26	077081

Replacement Lamp Holders

Description	Part Number	Product Code
7/9 Watt Lamp Holder	LLH 7/9	072843
13 Watt Lamp Holder	LLH 13	072849
18 Watt Lamp Holder (4 Pin)	LLH 18	072818
26 Watt Lamp Holder (4 Pin)	LLH 26	077082

Ballasts

Description	Part Number	Product Code
7/9 Watt Magnetic Ballast (NPF)	LEB 7/9	072842
13 Watt Magnetic Ballast (NPF)	LEB 13	072848
18 Watt Electronic Ballast (HPF)	LEB 18	077224
26 Watt Electronic Ballast (HPF)	LEB 26	077080

Gaskets

Description	Part Number	Product Code
Box Gasket	LBGASK 150	072820
Lamp Gasket	LLGASK 150	076971



Cor-Line ENT – Savings for the Long Run

Noncorroding and nonconducting, Cor-Line Electrical Nonmetallic Tubing and fittings are designed *For The Long Run*. Coiled in lengths up to 1,500 feet, the Cor-Line system can span the longest run. Encased in concrete, concealed in walls or ceilings, Cor-Line offers the best alternative to the labour-intensive, 10' lengths of metal conduit with its couplings and scrap. The Cor-Line System is the right choice!

Kwikon Fittings

Our unique Kwikon couplings, transition couplings and connectors are designed with six 360° locking tabs to ensure a secure concrete-tight connection.

Time-consuming taping and solvent cementing are eliminated.



C22.2 – No. 227.1

Ease of Installation

Engineered for the rugged day-to-day challenges of the construction industry, Cor-Line has already established itself as a market leader. Requiring no special tools for bending or cutting, Cor-Line is easily installed.



Bending & Cutting

Cor-Line's corrugated construction allows it to be easily bent by hand, no longer requiring special bending equipment traditionally required with metal conduit systems. When bending, ensure the radius of the curve is at least six times the internal diameter of the tubing.



Pre-Assembly of Kwikon Slab Boxes

IPEX's Kwikon slab boxes are available with or without molded connectors. For boxes without molded connectors, pre-assembly is quick and simple using our snap-in connector or threaded male adapter with locknuts. Both provide a secure concrete-tight connection.



Pre-Assembly of Metallic Boxes

Metallic slab boxes can be quickly pre-assembled with Kwikon connectors. Secured with a locknut, Kwikon connectors provide a concrete-tight connection.



Installation in Sheer Walls, Interior Walls & Block Walls

Cor-Line's flexibility, lightweight and ease of handling in metal, wood, or block walls, combined with Kwikon connectors and couplings, substantially reduce time and labour needed to install electrical raceways.



Pulling Wire

Kwikon's interior corrugated surface greatly reduces the amount of friction while pulling conductors through long runs, even with 90° bends.



CSA Certified

Cor-Line Electrical nonmetallic tubing and Kwikon fittings are certified to CSA C22.2 No. 227.1.



FT-4 Approved

IPEX Cor-Line ENT tubing meets and exceeds the requirements of CSA's vertical char test as described in Clause 4.11.4 of CSA C22.2 No. 0.3M.

Direct Burial

The Canadian Electrical Code approves ENT for direct earth burial. Rules governing installation of Cor-Line ENT are covered in the CEC Part 1, Rule 12-1500 through 12-1516.

Installation in Noncombustible/Combustible Construction

Refer to Section 3.1.5.19 of the National Building Code for rules governing the use of combustible conduit in noncombustible and/or combustible buildings. Where provincial codes vary, please consult with the building authority having jurisdiction.



Nonmetallic Raceways for Fire Alarm System Conductors

Rule 32-102 of the CEC allows Cor-Line ENT to be used for fire alarm systems in noncombustible or combustible buildings provided: (1) the raceway is embedded in at least 50mm (2 in.) of masonry or poured concrete, and (2) where electrical nonmetallic tubing (ENT) is used, the transition from ENT to metal raceways is made in the concrete using a transition fitting or other acceptable means. (Kwikon transition fittings are specifically designed for this application.)



Reel & Coil Size



	Size (in)	Length (ft)	Product Code	Weight lbs/pkg
Reel	1/2	1500	012004	185
	3/4	1000	012009	145
	1	750	012019	155
	1-1/4	1000	012047	205
	1-1/2	750	012033	180
	2	500	012044	160
	2-1/2	325	012049	70
Coil	1/2	370	012000	37
	3/4	240	012008	30
	1	160	012018	28
	1-1/4	500	012046	102
	1-1/2	300	012032	72
	2	225	012043	62

Wrapped in plastic, coils are easily dispensed from the centre.

10' Sticks

Size (in)	Length (ft)	Product Code	Weight lbs/pkg
1/2 x 10'	3600	012005	345
3/4 x 10'	2200	012006	315
1 x 10'	1800	012007	345

Cor-Line Dimensions

Size (in)	ID (in)	OD (in)
1/2	0.574	0.840
3/4	0.778	1.050
1	1.000	1.315
1-1/4	1.340	1.660
1-1/2	1.574	1.900
2	2.020	2.375
2-1/2	2.469	2.866

Weight Comparison of Cor-Line ENT vs EMT

Size (in)	ENT lbs/1000'	EMT lbs/1000'
1/2	100	295
3/4	125	440
1	175	668
1-1/4	185	970
1-1/2	220	1,100
2	319	1,517

Kwikon Coupling



Size (in)	Part Number	Product Code	Package Qty
1/2	KC10	089000	150
3/4	KC15	089001	100
1	KC20	089002	50
1-1/4	KC25	189670	30
1-1/2	KC30	189671	30
2	KC35	189672	20
2-1/2	KC40	089075	15

Kwikon Connector For Concrete Encasement



Size (in)	Part Number	Product Code	Package Qty
1/2	KTA10	089006	150
3/4	KTA15	089007	100
1	KTA20	089008	50
1-1/4	KTA25	189680	30
1-1/2	KTA30	189681	30
2	KTA35	189682	20
2-1/2	KTA40	089076	15

Kwikon Snap-in Connector



Size (in)	Part Number	Product Code	Package Qty
1/2	KTS10	089146	150
3/4	KTS15	089147	100
1	KTS20	089148	50

Kwikon Transition Coupling



Size (in)	Part Number	Product Code	Package Qty
1/2	KTC10	089012	125
3/4	KTC15	089013	100
1	KTC20	089014	50



Kwikon 90° Stub Down Fittings



KT90 Stub Down Fittings (Kwikon x Threaded)

Size (in)	Part Number	Product Code	Package Qty
1/2	KT90-10	089060	40
3/4	KT90-15	089059	35
1	KT90-20	089058	25

KK90 Stub Down Fittings (Kwikon x Kwikon)



Size (in)	Part Number	Product Code	Package Qty
1/2	KK90-10	089055	40
3/4	KK90-15	089056	35
1	KK90-20	089057	25

Kwikon ENT Form Stubby



Size (in)	Part Number	Product Code	Package Qty
1/2	KSTB-10	089330	150
3/4	KSTB-15	089331	150
1	KSTB-20	089332	150
1-1/4	KSTB-25	089333	150

Kwikon ENT Multi-Link™ Form Stubby



Size (in)	Part Number	Product Code	Package Qty
1/2	MSTB-10	089031	75
3/4	MSTB-15	089026	75
1	MSTB-20	089025	50

Kwikon ENT Angled Form Stubby



Size (in)	Part Number	Product Code	Package Qty
1/2	KASTB-10	089233	50
3/4	KASTB-15	089234	50
1	KASTB-20	089235	50
1-1/4	KASTB-25	089236	50
1-1/2	KASTB-30	089238	50

Kwikon Slab Box

Engineered to be rugged and durable, IPEX's boxes will withstand construction's harshest environments.

Designed by contractors for contractors, Kwikon slab boxes are available in two unique styles, with or without molded connectors. Now you can provide a complete, nonmetallic slab system. Priced competitively with traditional steel mud boxes, Kwikon slab boxes increase labour efficiencies, reducing costs.

Features

- Approved for use with ceiling fans up to 35 lbs. and luminaries up to 50 lbs.
- Concrete tight
- All molded connectors have 360° locking tabs that exceed CSA and UL requirements for pull-out
- Molded connectors are also approved for use with Scepter Rigid PVC Conduit
- Manufactured from high impact PVC
- Nonmetallic / Nonconducting / Noncorroding
- Threaded brass inserts
- Clear Vue vacuum formed removable covers

Slab Box w/ Molded Connectors



Hub Size (in)	Part Number	Product Code	Package Qty
8 x 1/2	SMBH-10	089455	25
4 x 1/2, 2 x 3/4, 2 x 1	SMBH-10/20	089456	25
4 x 1/2, 4 x 3/4	SMBH-10/15	089457	25
8 x 3/4	SMBH-15	089459	25
4 x 3/4, 4 x 1	SMBH-15/20	089463	25

Slab Box w/o Molded Connectors



Knockout Size (in)	Part Number	Product Code	Package Qty
8 x 1/2	SMB-10	089450	25
4 x 1/2, 2 x 3/4, 2 x 1	SMB-10/20	089451	25

Slab Box Extension Ring



Part Number	Product Code	Standard Packaging
SMBR	089494	20

Adjusts height of SMB/SMBH series slab boxes by 1"



4" Square Slab Box



Hub Size (in)	Part Number	Product Code	Package Qty
8 x 1/2	SSBH-10	089452	25
8 x 3/4	SSBH-15	089453	25
4 x 1/2 & 4 x 3/4	SSBH-10/15	089454	25
4 x 3/4, 4 x 1	SSBH-15/20	089471	25

Shallow Slab Box



Hub Size (in)	Part Number	Product Code	Package Qty
8 x 1/2	SMBSH-10	089485	20
4 x 1/2 & 4 x 3/4	SMBSH-10/15	089486	20
8 x 3/4"	SMBSH-15	089487	20
4 x 1/2, 2 x 3/4, 2 x 1	SMBSH-10/20	089488	20
4 x 3/4 & 4 x 1	SMBSH-15/20	089489	20

Concrete Wall Boxes

- Fully assembled and installation ready
- Perfectly suited for deep or shallow construction preferences
- Concrete-tight poly film covering the box opening
- Kwikon hubs do not protrude inside the box
- Clear Vue vacuum formed removable covers



Kwikon Concrete 3-1/2" Deep Concrete Wall Box

Hub Size (in)	Part Number	Product Code
4 x 1/2, 4 x 3/4	SVDBH-10/15	089496
4 x 3/4, 4 x 1	SVDBH-15/20	089049
4 x 1/2, 2 x 3/4, 2 x 1	SVDBH-10/20	089052
8 x 3/4	SVDBH-15	089065

Kwikon 2" Shallow Concrete Wall Box



Hub Size (in)	Part Number	Product Code
4 x 1/2	SVSBH-10	089054
4 x 3/4	SVSBH-15	089053

The **ENT Support Unit (ESU)** raises the tubing or conduit up off the concrete form during the concrete pour maintaining a level raceway and allows for maximum aggregate flow and concrete consolidation.



Easy to use, the ESU snaps around any size of ENT. It is perfect for use in high rise buildings constructed with post-tensioned (PT) concrete slabs.

Features

- One size fits all 1/2" - 2"
- Saves time and labour
- Easy locking mechanism
- Securable to the concrete form
- Minimal footprint reduces amount of surface contact

Part Number	Product Code
ESU-10-35	089149

Accessories

Tapered Plugs



Size (in)	Part Number	Product Code	Package Qty
1/2	TP10	089003	100
3/4	TP15	089004	100
1	TP20	089005	100

Kwikon Cutter & Blades



Description	Part Number	Product Code
Cutter (1/2"- 1")	CLC20	988210
Blades for CLC20	SSB	988915
Cutter (1/2"- 2")	CLC35	988211
Blades for CLC35	SB35	988916



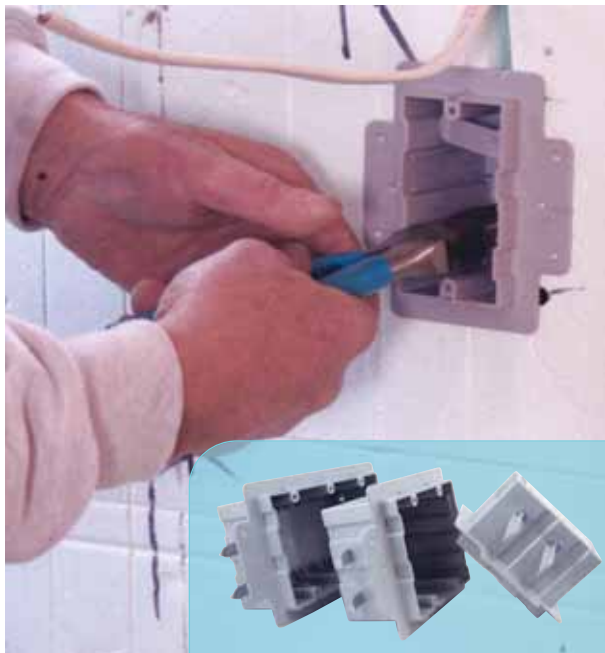

INEXO Boxes for ICF Construction

Until now there have been few choices when attempting to provide a truly professional electrical box solution for Insulated Concrete Form homes.

INEXO's patented design provides a truly professional solution that works with your production schedule and provides the quality installation and finished look that builders require and owners appreciate. INEXO boxes link seamlessly with existing ICF materials, tools and methods. A complete offering designed for ICF walls allow builders to standardize on the use of electrical boxes throughout the building.

Residential (NMD Cable 14/2 – 10/3)



Description	Part Number	Product Code
Single Gang	ICF-1-RLX	220003
Double Gang	ICF-2-RLX	220004
Triple Gang	ICF-3-RLX	220005

Commercial (AC or NMD Cable)



Description	Part Number	Product Code
Single Gang	ICF-1-CU	220006
Double Gang	ICF-2-CU	220007
Triple Gang	ICF-3-CU	220008



Super Duct Pipe and Fittings

Super Duct is recognized by major utilities, contractors and engineering firms as the premier ducting product available on the market.

Super Duct is manufactured with a specialized compound and engineered for high impact and crush strength specifically required by utilities for underground duct. This compound enhances the friction coefficient of Super Duct for easier pulling of conductors/wires through long runs.

Rigid Super Duct (Type DB-2) conforms to the testing requirements of CSA Standard C22.2 No. 211.1 both for encasement in concrete/masonry and for direct burial.



CSA C22.2
No. 211.1



Lightweight

Super Duct is easy to carry and install, reducing labour and costs.

Long Lengths

Super Duct is available in 10' and 20' lengths, minimizing the number of connections needed.

Bell Ends

Super Duct is bell-ended, allowing for easy assembly in the field.

High Compressive Strength

Super Duct's specially formulated compound is designed to withstand high loads.

Low Coefficient of Friction

The smooth bore of Super Duct facilitates cable pulling and eliminates costly cable damage.

Quality Control

Stringent, continuous testing ensures that Super Duct is a consistently high quality product.



Super Duct (Type DB-2)

Description	CSA Requirements	Reference
Pipe Stiffness @ 5%	43.5 psi (300 kPa)	CSA C22.2 No. 211.1
Crush Resistance	198 lbs. @ 73°F (90 kg @ 23°C) 10% max. residual deflection	CSA C22.2 No. 211.1
Impact Resistance	45 ft. lbf @ 73°F (61J @ 23°C) 25 ft. lbf @ 0°F (34J @ -18°C)	CSA C22.2 No. 211.1
Residual Stress	149°F (65°C) for 4 hours. Allow to cool to 73°F (23°C). 0.5% shrinkage allowed.	CSA C22.2 No. 211.1
Joint Tightness	5 psi (35 kPa) internal water pressure applied for 24 hours.	CSA C22.2 No. 211.1

Note: Super Duct meets or exceeds all CSA requirements.

Field Bending

The natural flexibility of IPEX Super Duct allows field bending, so minor changes in elevation or direction can often be accommodated without the use of special sweeps or fittings. The following table indicates typical maximum offset bends that can be achieved by "cold bending."

Allowable Offset for Super Duct

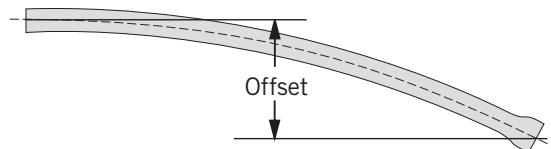

Size	Max Allowable Offset 10' Length		Max Allowable Offset 20' Length		
	in.	mm	in.	mm	
2	50	20	508	79	2 007
3	75	14	356	56	1 422
3-1/2	90	12	305	49	1 245
4	100	11	279	43	1 092
5	125	7	178	35	889
6	150	7	178	29	737

NOTES:

1. Axial deflection should not be attempted at the joints.
2. The above values were established for ambient temperatures above the freezing point. Increased radii may be desirable at below-freezing temperatures.



Bends

Standard 90°, 45° and 22 1/2° bends are available from sizes 2" through to 6" in 24", 36", 42" and 60" radius. All bends are supplied with 6" (15.2cm) tangents. The centre line lay length (L) can be calculated using;

$$L = \left(\pi r \times \frac{\$}{180} \right) + 2 \text{ (tangent)}$$

Where: $\pi = 3.14$

L = centre line lay length

r = radius of bend

$\$$ = angle of bend

tangent = 6"

Example: for a 3" 90° bend with a 36" radius - calculate the lay length:

$$L = \left(3.14 \times 36 \times \frac{90^\circ}{180^\circ} \right) + 2 (6)$$

$$L = 69 \text{ inches}$$

$$L \text{ (metres)} = \frac{L \text{ imperial}}{12 \times 3.281} = \frac{69}{39.37} = 1.75\text{m}$$

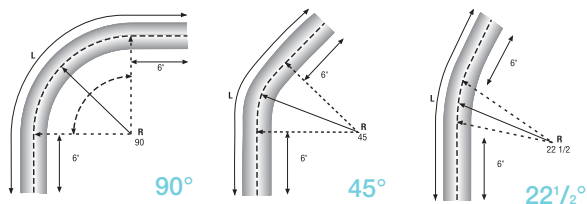

Static Friction Coefficient

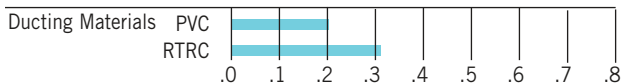

Concrete Encased Duct Installation

For multipurpose power cable and communication duct banks, spacing between ducts is critical for optimum performance. IPEX has designed the Monobloc and Vertical Lok Spacer systems to accommodate all specification and field installations.

These light weight spacers provide the vertical and horizontal separation required in a trench.

With spacers in place on the trench bottom, lay the first tier of ducts. When using a concrete base, lay the bottom tier before the base has taken initial set. Place subsequent tiers of spacers on top of the tier until the required number of ducts are installed. Then tie the entire assembly together. It is not necessary to weight or brace the bank unless the concrete mix is very wet.



The Concrete Pour

Do not allow a heavy mass of concrete to fall directly onto the duct. If this is a possibility, use a plank to direct the concrete down the sides of the bank assembly to the trench bottom. The concrete will flow to the centre of the bank and rise up in the middle, uniformly filling all open spaces. Voids can be eliminated by carefully working a long, flat slicing bar or spatula up and down between the vertical rows of ducts. Concrete should then flow between and under all of the ducts.

Duct Bank Elevation

Monobloc spacers should be staggered. It is recommended that spacers be located approximately one-fifth of duct length from each end. Vertical Lok spacers should be located to a maximum of every 5.5 ft. (1.7m).

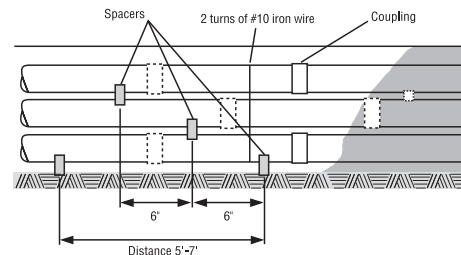

Backfilling

Backfill with regular excavated soil after the concrete has set.



Concrete Encased Tier-by-Tier Installation

The advantage of this method is the production of a solid, void-free concrete envelope. Simply pour each tier independently.

Trench Bottom

After grading the trench, place a foundation of 3" of concrete on the bottom. It should be smooth and graded.

Bank Assembly

Lay the bottom tier of ducts on the concrete base. Ducts should be spaced with wooden combs (two per duct length). Concrete the first tier level to the top of the comb. Remove combs and fill the voids. Light tamping will ensure an even surface. Repeat this sequence until the bank is built up.



Type of wood comb used.

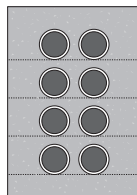

Cross-section of tier-by-tier method.

Concreting

If the concrete is allowed to set before assembling the next tier, the concrete will be stronger and more dense and the ducts will be aligned straighter. One problem with this method is that the bank will be in a series of layers and therefore more likely to heave and separate under frost conditions. If successive tiers are laid before the concrete has set, a satisfactory bond will be achieved by tamping the dry concrete.

Backfilling

Backfill with regular excavated soil when the bank is complete.

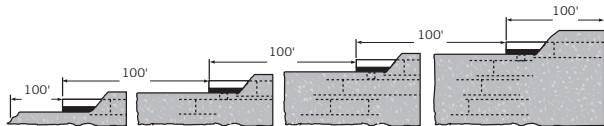

Duct is usually laid in 100' sections once the trench is excavated. Therefore, concreting can be a continuous process.

Direct Burial Installation

Trench Bottom

The trench bottom should provide a continuous, firm and uniform support for the duct bank construction. Care should be taken to avoid lumps, ridges, depressions and stones causing "point" contacts or uneven bearing.

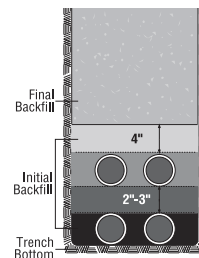

Rock or Shale

Excavate 3" below the desired depth and bring the trench back to grade with selected tamped soil. This will provide the duct with a uniform bedding surface.

Unstable Soils

Tests should be conducted to establish the soil strength in marshy or swampy areas. It may be necessary in these conditions to dig deeper and refill with crushed stone or gravel, or to employ mats, timbers or a concrete base.

Placement of Duct

After the first tier of ducts is installed, backfill and compact as outlined below. If wood combs are employed for spacing, remove them as the backfill is placed and tamped. Then begin the next tier.

Initial Backfilling

1. Fit side and centre to the top of the ducts. Use a hand tamper only to tamp firmly.
2. Backfill over the duct to the required thickness (see note) and tamp firmly, using only a hand tamper.

Final Backfilling

When the last tier is placed, hand-place the backfill to 4" over the duct with soil that does not contain stones larger than 3/8". Hand-tamping of this layer is optional, depending on the specifications.

From this point, backfill may be completed by hand or by pneumatic tamping in layers from 4" to 12" depending on the degree of compaction desired.

When placing backfill by machine, avoid the use of large rocks until a protective layer (minimum of 12") is established.

Note: In direct burial, no spacer should be used with Type 2; spacers provide "point" support instead of the continuous bed required. Backfill thickness between ducts is usually 2" to 3".



CSA Type II

Dimension (in)	10' L Belled		20' L Belled		Wgt/100' (lbs)
	Product Code	Ft/Crate	Product Code	Ft/Crate	
2	008220	2,460	008221	4,920	33.7
3	008230	1,120	008231	2,240	61.2
3-1/2	008235	810	008236	1,620	77.3
4	008240	630	008241	1,260	99.2
5	008250	430	008251	860	159.6
6	008260	280	008261	560	226.6

CSA Type II Split Duct

Dimension (in)	Product Code	Ft/Crate	Weight/100' (lbs)
2	008222	2,460	33.7
3	008232	1,120	61.2
3-1/2	008237	810	77.3
4	008242	630	99.2
5	008252	430	159.6
6	008262	280	226.6

Super Duct Dimensions in Inches

Duct Diameter	Minimum ID	Nominal Wall	Average OD
2	2.001	.082	2.250
3	3.000	.097	3.250
3-1/2	3.480	.109	3.730
4	3.941	.120	4.216
5	4.974	.153	5.299
6	5.896	.180	6.275

Super Duct Dimensions in Millimetres

Duct Diameter	Minimum ID	Nominal Wall	Average OD
50	50.83	2.08	57.15
75	76.20	2.46	82.55
90	88.39	2.77	94.74
100	100.10	3.05	107.09
125	126.34	3.89	134.60
150	149.76	4.57	159.39

PVC Coupling - Solvent Weld



Dimension (in)	Part Number	Product Code
2	SWC020	029001
2 (long)	SWC020L	029009
3	SWC030	029002
3-1/2	SWC035	029003
4	SWC040	029004
5	SWC050	029005
6	SWC060	029006

Polyethylene Coupling - Push Fit*



Dimension (in)	Part Number	Product Code
2	PFC020	029011
3	PFC030	029012
3-1/2	PFC035	029013
4	PFC040	029014
5	PFC050	029015
6	PFC060	029016

* Suitable for concrete-encased applications only

PVC 5° Coupling - Solvent Weld



Dimension (in)	Part Number	Product Code
2	5ACS20	029041
3	5ACS30	029042
3-1/2	5ACS35	029043
4	5ACS40	029044
5	5ACS50	029045
6	5ACS60	029046

Polyethylene 5° Coupling - Push Fit*



Dimension (in)	Part Number	Product Code
2	5APF20	029620
3	5APF30	029030
3-1/2	5APF35	029502
4	5APF40	029998
5	5APF50	029050

* Suitable for concrete-encased applications only



Expansion Joint



Dimension (in)	Part Number	Product Code
2	EXPJ20	029151
3	EXPJ30	029152
3-1/2	EXPJ35	029153
4	EXPJ40	029154

Reducer Coupling – Solvent Weld



Dimension (in)	Part Number	Product Code
3 x 2	RC3020	029021
3-1/2 x 2	RC3520	029039
3-1/2 x 3	RC3530	029022
4 x 2	RC4020	029023
4 x 3	RC4030	029024
4 x 3-1/2	RC4035	029025
5 x 4	RC5040	029026
6 x 4	RC6040	029027

Split Wye – Solvent Weld

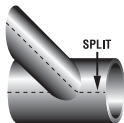

Dimension (in)	Part Number	Product Code
2	SPLY20	029051
3	SPLY30	029052
3-1/2	SPLY35	029053
4	SPLY40	029054

PVC Bell Ends



Dimension (in)	Part Number	Product Code
2	BELL20	029061
3	BELL30	029062
3-1/2	BELL35	029063
4	BELL40	029064
5	BELL50	029065
6	BELL60	029066

Terminator with Knock-Out Plugs



Dimension (in)	Part Number	Product Code
3	TERM30	029826
3 1/2	TERM35	029523
4 (with holes)	TERM40H	029822
4 (no holes)	TERM40W	029827

Cap – Solvent Weld



Dimension (in)	Part Number	Product Code
2	SWCA20	029071
3	SWCA30	029072
3-1/2	SWCA35	029073
4	SWCA40	029074
5	SWCA50	029075
6	SWCA60	029076

90° Long Sweep Bend

Dimension (in)	Part Number	Product Code
2 x 24 R	902024	029091
2 x 36 R	902036	029092
2 x 60 R	902060	029036
3 x 24 R	903024	029055
3 x 36 R	903036	029093
3 x 60 R	903060	029134
3-1/2 x 24 R	903524	029123
3-1/2 x 36 R	903536	029094
3-1/2 x 60 R	903560	029135
4 x 24 R	904024	029047
4 x 36 R	904036	029095
4 x 60 R	904060	029096
5 x 42 R	905042	029097
5 x 60 R	905060	029037
6 x 60 R	906060	029098



45° Long Sweep Bend

Dimension (in)	Part Number	Product Code
2 x 24 R	452024	029111
2 x 36 R	452036	029112
3 x 24 R	453024	029082
3 x 36 R	453036	029113
3-1/2 x 36 R	453536	029114
4 x 24 R	454024	029128
4 x 36 R	454036	029115
4 x 60 R	454060	029116
5 x 42 R	455042	029117
6 x 60 R	456060	029118



22 1/2° Long Sweep Bend

Dimension (in)	Part Number	Product Code
3 x 36 R	223036	029085
4 x 36 R	224036	029204
5 x 42 R	225042	029249



Note: Special radius bends are available upon request.

Tapered Plug



Dimension (in)	Part Number	Product Code
2	PLUG20	029131
3	PLUG30	029132
3-1/2	PLUG35	029133
4	PLUG40	029078
5	PLUG50	029079
6	PLUG60	029136



Universal Pipe Plug

Dimension (in)	Part Number	Product Code
2 & 2-1/2	UPP35	029386
3 & 3-1/2	UPP45	029387
4	UPP55	029388
5	UPP60	029389
6	UPP65	029390

Female Adapter



Dimension (in)	Part Number	Product Code
2	FEMA20	029141
3	FEMA30	029142
3-1/2	FEMA35	029143
4	FEMA40	029144
5	FEMA50	029145
6	FEMA60	029146



Conduit to Duct Adapter

Dimension (in)	Part Number	Product Code
2	ARIG20	029181
2 (long)	ARIG20L	029188
3	ARIG30	029182
3-1/2	ARIG35	029183
4	ARIG40	029184
5	ARIG50	029185
6	ARIG60	029186

Note: Duct to RTRC Conduit Adapters are available on request.

Reducing Adapter Coupling –
Duct to PVC Conduit

Dimension (in)	Part Number	Product Code
3 x 2	ARIG3020	029191
4 x 2	ARIG4020	029192
4 x 3	ARIG4030	029187

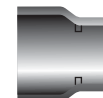
PVC Adapter Coupling – Asbestos
Cement or Bituminous Fibre

Dimension (in)	Part Number	Product Code
3-1/2	ACFB35	029163
4	ACFB40	029164



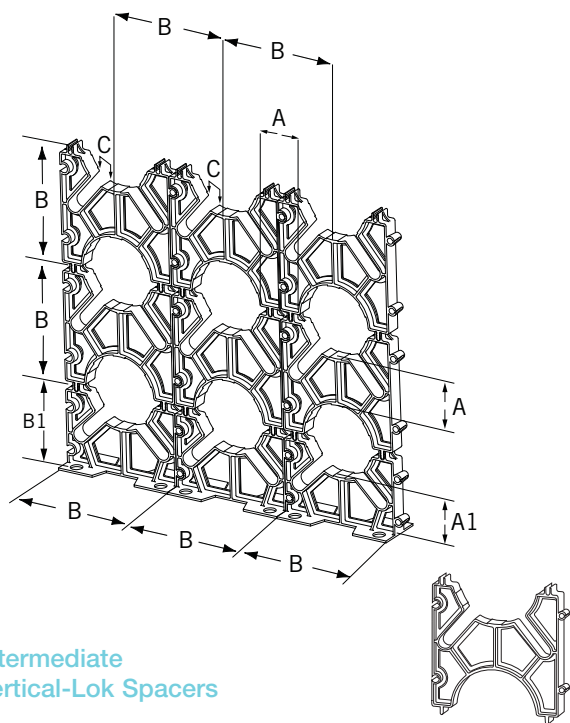

Intermediate Vertical-Lok Spacers

Dimension n (in)	Part Number	Product Code	A inches	B inches	C inches
2 x 1-1/2	IS3530	029550	1.500	3.937	0.62
2 x 2	IS3535	029551	2.000	4.483	0.62
2 x 3	IS3545	029552	3.000	5.438	0.62
3 x 1-1/2	IS4530	029553	1.500	5.130	no rebar slots
3 x 2	IS4535	029554	2.000	5.625	0.87
3 x 3	IS4545	029555	-	6.614	0.87
4 x 1	IS5520	029556	1.000	5.630	no rebar slots
4 x 1-1/2	IS5530	029557	-	6.614	0.87
4 x 2	IS5535	029558	2.000	6.625	0.87
4 x 3	IS5545	029559	3.000	7.625	0.87
5 x 1-1/2	IS6030	029560	1.500	7.325	no rebar slots
5 x 2	IS6035	029561	2.188	7.813	0.87
5 x 3	IS6045	029562	3.188	8.875	0.87
6 x 1-1/2	IS6530	029563	-	7.441	0.87
6 x 2	IS6535	029564	-	7.677	0.87
6 x 3	IS6545	029565	3.000	9.750	0.87
8 x 2	IS8035	029294	-	-	no rebar slots

Intermediate Vertical-Lok Spacers (Duct Pipe Only)

Dimension (in)	Part Number	Product Code
* 4 x 1-1/2	IS5530D	029340
* 4 x 2	IS5535D	029341

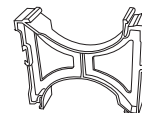

* Not supplied with rebar holder slots.

Base Vertical-Lok Spacers

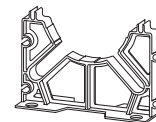

Dimension n (in)	Part Number	Product Code	A inches	B inches	C inches
2 x 1-1/2	BS3530	029566	2.992	3.937	0.62
2 x 2	BS3535	029567	2.992	4.488	0.62
2 x 3	BS3545	029568	2.992	5.433	0.62
3 x 1-1/2	BS4530	029569	3.000	4.615	no rebar slots
3 x 2	BS4535	029570	2.992	5.630	0.87
3 x 3	BS4545	029571	2.992	6.614	0.87
4 x 1	BS5520	029572	1.750	4.060	no rebar slots
4 x 1-1/2	BS5530	029573	2.992	6.614	0.87
4 x 2	BS5535	029574	2.992	6.614	0.87
4 x 3	BS5545	029575	2.992	7.638	0.87
5 x 1-1/2	BS6030	029576	3.000	6.900	no rebar slots
5 x 2	BS6035	029577	2.992	7.874	0.87
5 x 3	BS6045	029578	2.992	8.701	0.87
6 x 1-1/2	BS6530	029579	3.031	7.441	0.87
6 x 2	BS6535	029580	3.031	7.677	0.87
6 x 3	BS6545	029581	2.992	9.764	0.87
8 x 2	BS8035	029293	-	-	no rebar slots

Base Vertical-Lok Spacers (Duct Pipe Only)

Dimension (in)	Part Number	Product Code
* 4 x 1-1/2	BS5530D	029440
* 4 x 2	BS5535D	029441

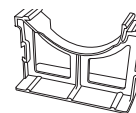

* Not supplied with rebar holder slots.



Monobloc Spacer Benefits for Telephone Duct:

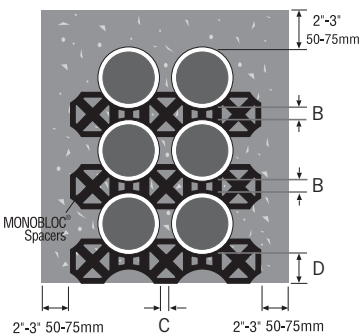

- lightweight; easy to handle and install
- weatherproof
- resilient at extremely low temperatures
- flexible, yet tough
- readily available in a wide range of sizes and configurations
- economical
- immune to corrosion attack
- approved by Bell Canada
- versatile, as they can be used as both a base & intermediate spacer

Selection Table (in inches)

Nominal Size (A)	Vertical Spacing (B)	Horizontal Spacing (C)	Ground Clearance (D)	Number of Ways (E)
2	1-1/2	1-1/2	3	2
3	1-1/2	1-1/2	3	2
3-1/2	1	1	2	2 - 3 - 4
4	1	1	2	1 - 2 - 3 - 4
4	1-1/2	1-1/2	3	2 - 3 - 4
4	2	2	3	1 - 2 - 3 - 4
4	3	3	3	2 - 3 - 4
4	3	3	4	2 - 3 - 4
4-1/2	2	2	3	1 - 2 - 3
5	1-1/2	2-1/8	3-5/8	1
5	1-1/2	1-1/2	3	2 - 3 - 4

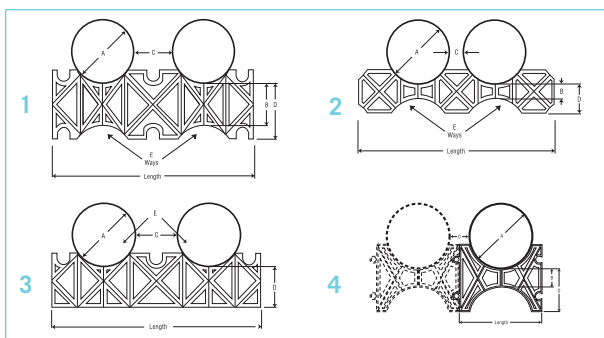

Monobloc Duct Spacers

Description (in A, B, C, D)	E	Product Code	Dimensional Drawing	F length (in)
2 x 1-1/2 x 1-1/2 x 3	2 way	029473	2	7.9
3 x 1-1/2 x 1-1/2 x 3	2 way	029474	2	10.3
3-1/2 x 1 x 1 x 2	2 way	029860	2	12.4
3-1/2 x 1 x 1 x 2	3 way	029861	2	17.3
3-1/2 x 1 x 1 x 2	4 way	029479	2	20.9
4 x 1 x 1 x 2	1 way	029475	2	8.3
4 x 1 x 1 x 2	2 way	029476	2	13.5
4 x 1 x 1 x 2	3 way	029477	2	18.8
4 x 1 x 1 x 2	4 way	029478	2	24.2
* 4 x 1-1/2 x 1-1/2 x 3	2 way	029470	1	14.2
* 4 x 1-1/2 x 1-1/2 x 3	3 way	029471	1	20.0
* 4 x 1-1/2 x 1-1/2 x 3	4 way	029472	1	26.0
* 4 x 2 x 2 x 3	1 way	029480	2	8.3
* 4 x 2 x 2 x 3	2 way	029464	1	14.5
* 4 x 2 x 2 x 3	3 way	029465	1	20.7
* 4 x 2 x 2 x 3	4 way	029499	1	27.0
* 4 x 3 x 3 x 3 (Base)	2 way	029466	3	15.0
* 4 x 3 x 3 x 3 (Base)	3 way	029488	3	22.5
* 4 x 3 x 3 x 3 (Base)	4 way	029489	3	30.0
* 4 x 3 x 3 x 4	2 way	029469	1	15.0
* 4 x 3 x 3 x 4	3 way	029497	1	22.5
* 4 x 3 x 3 x 4	4 way	029498	1	30.1
4-1/2 x 2 x 2 x 3	1 way	029485	2	8.7
4-1/2 x 2 x 2 x 3	2 way	029486	2	15.5
4-1/2 x 2 x 2 x 3	3 way	029487	2	22.2
5 x 1-1/2 x 2-1/8 x 3-5/8	1 way	029455	4	7.0
5 x 1-1/2 x 1-1/2 x 3	2 way	029494	2	16.2
5 x 1-1/2 x 1-1/2 x 3	3 way	029495	2	23.1
5 x 1-1/2 x 1-1/2 x 3	4 way	029496	2	30.0

* Spacers have provisions for re-bar. (re-bar slots)





SceptaCon™ Trenchless Raceway Systems

SceptaCon is one of the first PVC systems designed for the rigors of trenchless applications. It links seamlessly to existing PVC conduit infrastructures and allows utility companies to standardize on PVC throughout their entire electrical systems.

SceptaCon's slide-in locking system and pre-installed, pre-lubricated gaskets allow contractors to create a water-tight seal by hand in seconds - in all temperatures - without having to worry about solvents or chemicals freezing or drying too quickly.

Its unique spline-lock snaps into a recessed opening, ensuring the spline won't get snagged during pull-through. SceptaCon's rounded bell shoulders slide easily past roots, rocks and other debris in the borehole, ensuring a smooth, easy installation. And because SceptaCon is made to the same high standards as our Scepter rigid PVC conduit, contractors and electrical utilities can be assured of the same level of quality - above ground and below.



No Cementing or Lubrication

SceptaCon's slide-in locking system and pre-installed, pre-lubricated gaskets allow contractors to create a water-tight seal by hand in seconds.

Outperforms Other PVC Products

SceptaCon's unique spline-lock snaps into a recessed opening, ensuring the spline won't get snagged during pull-through. SceptaCon's rounded bell shoulders slide easily past roots, rocks and other debris in the borehole, ensuring a smooth, easy installation.

No Fusion Required

Because SceptaCon's joints can be quickly joined by hand in seconds, crews don't need large, expensive fusion equipment or special training to create water-tight joints. In addition, SceptaCon can be assembled one pipe length at a time, then pulled underground, eliminating the need for long strings of pipe on the job.

Superior Performance

SceptaCon is made from durable schedule 40 PVC that's resistant to creasing, scoring or flattening when pulled past obstructions in the borehole, yet flexible enough to bend with underground twists and turns. SceptaCon remains round, unlike HDPE which can stretch and become oval.

Easy to Handle

SceptaCon is available in convenient 10' and 20' lengths that are light-weight, easy to handle and no problem to work with in all types of weather.



SceptaCon™ Raceway

Length	Product Code
2" x 20'	106421
3" x 10'	106430
3" x 20'	106431
4" x 10'	106440
4" x 20'	106441
5" x 10'	106450
5" x 20'	106451
6" x 10'	106460
6" x 20'	106461

SALES AND CUSTOMER SERVICE

Customers call IPEX Electrical Inc.

Toll free: (866) 473-9462

www.ipexna.com

About the IPEX Group of Companies

As leading suppliers of thermoplastic piping systems, the IPEX Group of Companies provides our customers with some of the world's largest and most comprehensive product lines. IPEX products are backed by more than 50 years of experience. With state-of-the-art manufacturing facilities and distribution centers across North America, we have earned a reputation for product innovation, quality, end-user focus and performance.

Markets served by IPEX group products are:

- Electrical systems
- Telecommunications and utility piping systems
- Industrial process piping systems
- Municipal pressure and gravity piping systems
- Plumbing and mechanical piping systems
- Electrofusion systems for gas and water
- Industrial, plumbing and electrical cements
- Irrigation systems
- PVC, CPVC, PP, PVDF, PE, ABS, and PEX pipe and fittings

Products are manufactured by IPEX Electrical Inc.

Cor-Line®, Inexo®, JBox™, Kwikon®, Monobloc®, SceptaCon™, Sceptalight™ and SuperDuct® are trademarks of IPEX Branding Inc.

www.ipexna.com

This literature is published in good faith and is believed to be reliable. However, it does not represent and/or warrant in any manner the information and suggestions contained in this brochure. Data presented is the result of laboratory tests and field experience.

A policy of ongoing product improvement is maintained. This may result in modifications of features and/or specifications without notice